



SAILOR
SYSTEM 4000
MF/HF 150W
Operator's Manual

Distress Call

Transmission of DSC distress alert on MF (2187.5 kHz)



1. If off: press ON/OFF.



2. Open DISTRESS lid.



3. Press DISTRESS button.

TX and Alarm indicators flashes and an intermittent sound starts.

If time permits, release the distress button and select the NATURE of distress.

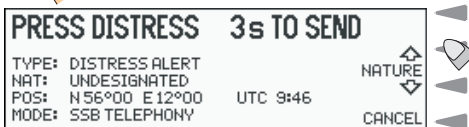

4. Press DISTRESS for 3 seconds.

TX and Alarm indicators becomes steady lit and the intermittent sound ceases.

Then the distress alert call will be sent on the DSC distress frequency 2187,5 kHz.

Wait for answer.

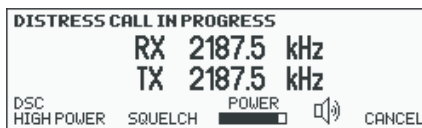

The distress alert call is transmitted five times in succession.

After 35 seconds the radio is set to the telephony distress frequency 2182 kHz.

The watch receiver is waiting for DSC acknowledgement.



The call attempt is automatically repeated approx. every 4 minutes if no DSC acknowledgement is received.

Acknowledgement

5. Press CONNECT or lift handset.

The radio is set to the telephony distress frequency.



6. Press the handset key and say:



“MAYDAY”

“This is”

- the 9-digit identity and the call sign or other identification of the ship,
- The ship's position,
- The nature of distress and assistance wanted,
- any other information which might facilitate the rescue.

“OVER.”

Release the handset key and listen for answer.

Release

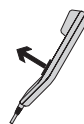

What is what?

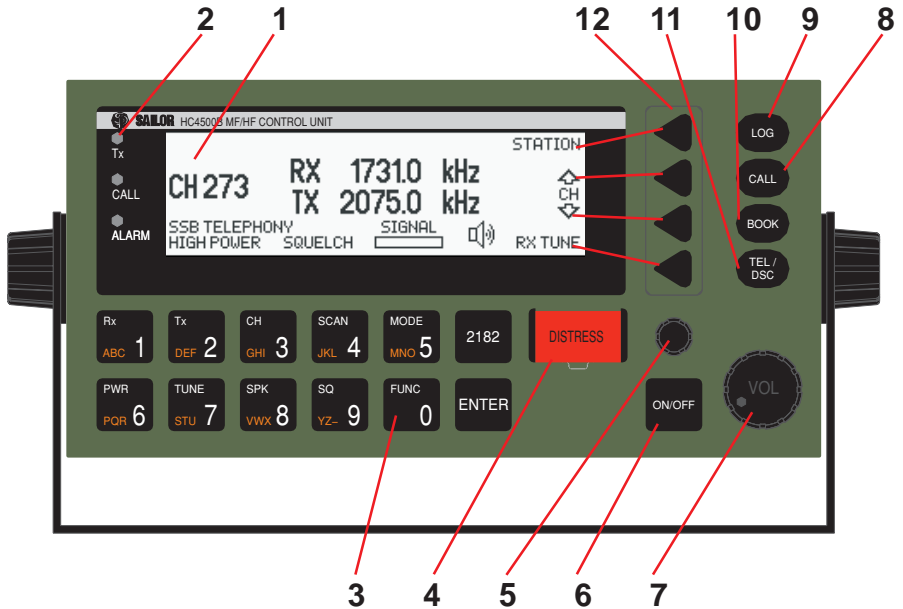

1. Display.
2. Indicator lamps.
 TX, steady light: Transmitting.
 TX, flashing: Distress button pressed (ALARM flashes in antiphase).
 CALL, flashing: DSC call received.
 ALARM, steady light: An alarm condition exists.
 ALARM, flashing: Distress or urgency call received.
3. Keyboard.
4. DISTRESS button. Protected by shield. To use, lift the shield and press for 3 seconds.
5. Dimmer control.
6. ON/OFF push button. To switch off, press for 2 seconds.
7. Volume control.
8. Press to start creating a DSC call.
9. Opens the Log over received and sent DSC calls.
10. Opens the DSC Address Book.
11. TEL/DSC function switch.
12. Soft keys. The function of each key is described in its respective line at the right edge of the display.

Introduction

Congratulations on your new SAILOR HC4500B MF/HF maritime radio telephone with built-in DSC (Digital Selective Calling) system, fulfilling the highest international standards for marine MF/HF communication and safety procedures. If connected to a GPS or other maritime navigation system it can automatically include the true UTC time and your position in its DSC distress messages. For an explanation of DSC, see page 2.

This SAILOR marine equipment is a part of the modular system 4000 which also includes a HF single sideband radiotelephone.

SAILOR marine equipment is specially designed for the extremely rugged conditions on board a ship, based on more than 50 years' experience with all kinds of boats, from small pleasure crafts, over fishing boats working under all climatic conditions, to the biggest ships.

SAILOR[®] is one of Europe's leading manufacturers of maritime radiocommunication equipment - a position which has been maintained by means of constant and extensive product development. We have a worldwide network of dealers with general agencies in more than 80 countries. All our dealers are specially trained to service all your SAILOR[®] products.

About this manual

This manual is for the daily user of the system. Additionally, it includes a section on the installation procedures, and - on page ii - standard distress procedures. **We highly recommend you to read the manual *before* you start using the equipment.**

Notice: There may be some minor differences in the graphic layout of the manual compared to the physical device.

Please note

Any responsibility or liability for loss or damage in connection with the use of this product and the accompanying documentation is disclaimed. The information in this manual is furnished for informational use only, is subject to change without notice, may contain errors or inaccuracies, and represents no commitment whatsoever. This agreement is governed by the laws of Denmark.

Doc. No.: B4500BGB0

Issue: B/0211



SAILOR[®] · Porsvej 2 · PO Box 7071 · DK-9200 Aalborg SV · Denmark
Phone: +45 9634 6100 · Fax: +45 9634 6101 · Telex: 69789 ECI DK
E-mail: sailor@sailor.dk · Web: www.sailor.dk

Contents

	Page
Distress Call	ii
What is what?	iii
Introduction	iv
About this manual	iv
Abbreviations Used in this Manual	2
MF/HF Fundamental info	3
Propagation of MF and HF Radio Waves	3
Radiotelephony	3
DSC	3
Basic Functions	4
Switch Supply On/Off	4
Switch Speaker On/Off	4
Switch to Telephony/DSC	4
Telephony Functions	4
Select 2182 kHz	4
Change Mode	4
Change Output Power	4
Re-tune the ATU	4
Switch Squelch On/Off	5
Telephony Display Functions:	5
Store a Channel	6
Select a channel from the station table	6
Listening for Calls	7
Making a Telephone Call	7
Scanning	7
Scanning types	8
DSC Functions	9
DSC Main Buttons	9
DSC Status Display	9
Set answer back mode	9
Receiving a Distress Call	10
Receiving an All Ships Call	11
Receiving an Individual Call	11
Sending a Test Call	12
Calling a Ship	13
Calling a Coast Station	15
Sending an All Ships Call	16
Repeat a Call	18
TX Call Menu	18
Changing a Function	19
The Function Menu	19
Installation	v
Compass safe distance	v
Dimensions and weights	v

Abbreviations Used in this Manual

AM	Amplitude Modulation
CU	Control Unit
DSC	Digital Selective Calling
GPS	Global Positioning System
HF	High Frequency
MF	Medium Frequency
MMSI	Maritime Mobile Service Identity
PTT	Push-To-Talk
RX	Receive
SSB	Single Side Band
TEL	Telephony
TX	Transmit
UTC	Co-ordinated Universal Time

MF/HF Fundamental info

Propagation of MF and HF Radio Waves

MF/HF radiocommunications provide a medium and long range service. The 1.6-4 MHz marine band is intended primarily for coastal operation beyond normal VHF communication range. A reliable range of more than 150 nautical miles can be expected in most areas in the daytime, more in the nighttime. Propagation of the radio waves in this band is mainly by ground waves i.e. the waves from the transmitter aerial follow the earth's curvature to the receiver aerial. The high frequency range 4 - 30 MHz can provide communication for hundreds or even thousands of nautical miles. The long range is achieved by sky waves reflected from the ionosphere. Propagation of the radio waves depends on a number of factors such as frequency, time of day, time of year, and solar activity. The channels allocated to the maritime mobile service in the HF range are divided into a number of bands: 4, 6, 8, 12, 16, 18, 22, 25 MHz to allow a suitable frequency band to be selected for communication dependent on distance and time of day.

Radiotelephony

The mode of emission used for telephony transmissions in the marine bands is SSB (single-sideband, J3E). AM mode is used when receiving broadcast transmissions. The international distress frequency for radiotelephony in the MF band is 2182 kHz. The frequencies for radiotelephone distress and safety traffic in the HF bands are 4125 kHz, 6215 kHz, 8291 kHz, 12290 kHz, and 16420 kHz. Working frequencies for public correspondence with coast stations are arranged in pairs for duplex/semi-duplex operation. For the HF bands these channels are allocated numbers by ITU on an international basis. For the MF band ITU numbers are allocated for Region I only. In addition a number of simplex frequencies are available in each band for ship-to-ship communication.

DSC

DSC (Digital Selective Calling) is an automatic calling system which allows a specific station to be contacted and made aware that a station wishes to communicate with it. In addition to calls to specific stations the system can also be used to call 'all ships' and groups of ships and this is of significance for its use for DSC distress alerting. DSC is an alerting signal only and the communication which follows is made on an appropriate working frequency using radiotelephony. The frequencies for DSC distress and safety calling are 2187.5 kHz, 4207.5 kHz, 6312 kHz, 8414.5 kHz, 12577 kHz, and 16804.5 kHz. Calling frequencies for public correspondence with coast stations are arranged in pairs, both international and national frequencies are assigned. In addition the frequency 2177 kHz may be used for ship-to-ship calling.

Basic Functions

Switch Supply On/Off



Switches equipment on when pressed. Switches equipment off when pressed for 2 seconds. Start-up display is 'Telephony' with last used settings.

Note: The equipment should always be switched on while at sea in order to maintain continuous DSC watch on 2187.5 kHz.

Switch Speaker On/Off



Switches loudspeaker on/off.

Switch to Telephony/DSC



Switches between Telephony display and DSC display.

Telephony Functions

Select 2182 kHz



Sets TX and RX frequency to the radiotelephone distress frequency 2182 kHz, selects SSB Telephony mode, sets Power level High, Squelch Off, Speaker On and increases Volume if lower than a preset level.

Change Mode



Changes between 'SSB TELEPHONY', 'AM BROADCAST', and 'DSC': Optionally 'LSB' and 'SSB REMOTE', if enabled. In AM BROADCAST mode TX frequency is shown dimmed and transceiver cannot be keyed.

Change Output Power



Changes between 'HIGH POWER' and 'LOW POWER'. DSC calls are automatically sent in 'HIGH POWER'. 'LOW POWER' cannot be selected on the six telephony distress frequencies.

Re-tune the ATU



Starts a TX tuning sequence. TX tuning is done automatically the first time the transmitter is keyed on a new frequency and before any DSC transmission.

Switch Squelch On/Off



Changes between squelch on, indicated in the Telephony Display by 'SQUELCH' and squelch off (no indication). When squelch is on the receiver is muted in speech pauses.

Squelch is automatically set to off by a change of RX frequency except during scanning.

Squelch is automatically set to on when scanning is activated and to off when scanning is deactivated.

May be switched on and off during scanning.

Always off in AM and SSB Remote mode. In SSB Remote mode control of the transceiver via the TU SYS connector is enabled.

Telephony Display Functions:

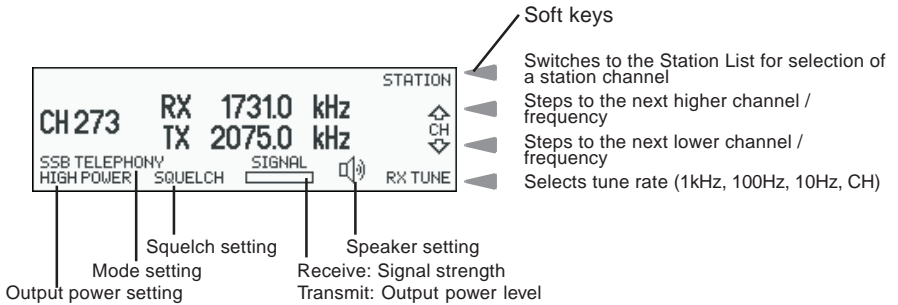

Select RX frequency, e.g. 2656.0 kHz:



Select TX frequency, e.g. 3210.0 kHz:



Select RX + TX frequency, e.g. 3545.0 kHz, simplex:

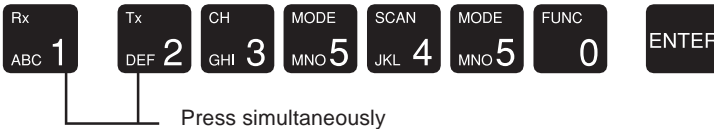

Select channel, e.g. 1208:



Pressing the ENTER softkey is equal to pressing Enter.

Pressing the TX softkey copies TX frequency to RX.

Pressing the RX softkey copies RX frequency to TX.

Pressing the SWAP softkey interchanges RX and TX frequencies.

Pressing the softkey deletes last entry.

Pressing the CANCEL softkey resets the display.

Store a Channel

Select the desired RX frequency, TX frequency and mode setting.

Press **CH** **3** and key in a channel number between 1 and 199.

If the channel number is free, the STORE softkey is available:

CH 27 - RX 3570.0 kHz STORE
 TX 3570.0 kHz
 SSB TELEPHONY SIGNAL
 HIGH POWER SQUELCH CANCEL

- Stores the channel
- Backspace, deletes the previous entry
- Selects the previous display

If the channel number is already used, the REPLACE softkey is available. Select REPLACE and confirm by pressing OK in the warning display that follows.

To delete a channel select the same channel number again. The DELETE softkey is available.

Select DELETE and confirm by pressing OK in the warning display that follows.

Select a channel from the station table

Press the STATION softkey in the Telephony Display:

SELECT STATION OK
 BLAAVAND RADIO
 LYNGBY RADIO STATION
 SSB TELEPHONY SIGNAL
 HIGH POWER SQUELCH CANCEL

- Selects the station
- Steps to the prev. station in alphabetic order
- Steps to the next. station in alphabetic order
- Returns to the previous telephony display

Station names are shown.

Select wanted station:

MODE	CH	RX kHz	TX kHz	TYPE	ENTER
SSB	1	1734.0	2078.0	CALL	ENTER
SSB	2	2593.0	3245.0	WORK	CH

SSB TELEPHONY SIGNAL
 HIGH POWER SQUELCH CANCEL

- Selects the channel and returns to telephony display
- Steps to the next higher channel of the station
- Steps to the next lower channel of the station
- Returns to the previous display

Channels allocated the selected station is shown.

Select channel:

CH 1 BLAAVAND RADIO STATION
 CH 274 RX 1734.0 kHz
 TX 2078.0 kHz
 SSB TELEPHONY SIGNAL
 HIGH POWER SQUELCH RX TUNE

The radio is ready for use on the selected channel.

For programming stations, please refer to FUNC menu.

Listening for Calls

Coast stations transmit traffic lists consisting of call signs/names of the ships for which they have traffic.

The traffic lists are sent at specified times and at intervals of typically two hours. They are broadcasted on the normal working frequencies on the coast station. Ships should, as far as possible, listen to the traffic lists transmitted by relevant coast stations. On hearing their call sign they should establish communication as soon as they can do so.

1. Select the appropriate station.
2. Select the channel on which traffic lists are transmitted.
3. Switch loudspeaker on and adjust volume to an appropriate level.

If on HF, traffic lists are transmitted in more frequency bands simultaneously, search for the channel with the best propagation conditions.

Making a Telephone Call

Wait until transmission of the traffic list has finished and the channel is free. Call the coast station on the working frequency on which the traffic list was received or as instructed by the coast station.

1. Hook off the handset.
2. Press the PTT key on the handset when speaking.
Say:
 1. <Called station's name (3 times)>
 2. 'This is' <Your ship's name (3 times)>
 3. 'Over'
3. Release the PTT key to listen.
4. When answered:

Follow the instructions from the coast station. The coast station may ask for further identification, information on position and next port of call, and may suggest another working channel for the traffic to follow. If the coast station is not ready to receive traffic immediately it may ask you to wait for a specific number of minutes.

Scanning



Starts/Stops scanning.

The last used scanning type is selected and squelch is set to on when scanning is activated. Speaker is set to on if the scanning type is Dual Watch, Multi Watch, or Telephony Watch. Scanning is stopped by pressing SCAN or ENTER or by lifting the handset off hook. For Multi Watch or Telephony Watch scanning stops on the presently scanned telephony channel, for Dual Watch and DSC Watch the previous telephony setting is restored. Scanning resumes when the handset is placed on hook again.

Scanning types

Telephony watch:

Up to 10 telephony channels.

SCANNING – TELEPHONY WATCH					EDIT
241	242	243	244	245	TYPE
246	<u>247</u>	248	249	250	
SSB TELEPHONY		SIGNAL		CANCEL	
HIGH POWER	SQUELCH				

- Switches to edit Telephony scanning table
- Switches to previous scanning type
- Switches to next scanning type
- Returns to previous telephony setting

Scanning rate is approx. one channel per 2 sec.

Multi watch:

A single DSC frequency (normally 2177 kHz) and up to 10 telephony channels.

SCANNING – MULTI WATCH					EDIT
241	242	243	244	245	TYPE
246	<u>247</u>	248	249	250	
DSC 2177.0kHz		SIGNAL		CANCEL	
SSB TELEPHONY					
HIGH POWER	SQUELCH				

- Switches to edit Multi Watch scanning table
- Switches to previous scanning type
- Switches to next scanning type
- Returns to previous telephony setting

Scanning rate is approx. one channel per 2 s. The DSC frequency is monitored briefly at each telephony channel shift.

Dual watch:

A single DSC frequency (normally 2177 kHz) and the current telephony frequency.

SCANNING – DUAL WATCH					EDIT
RX 2182.0kHz					TYPE
DSC 2177.0kHz		SIGNAL		CANCEL	
SSB TELEPHONY					
HIGH POWER	SQUELCH				

- Switches to edit DSC scanning frequency
- Switches to previous scanning type
- Switches to next scanning type
- Returns to previous telephony setting

The DSC frequency is monitored briefly at approx. each 2 s.

DSC watch:

Up to 6 DSC frequencies.

SCANNING – DSC WATCH			EDIT	
2177.0kHz	4219.5kHz	6331.0kHz	TYPE	
<u>8436.5kHz</u>	12657.0kHz	16903.0kHz		
DSC		SIGNAL		CANCEL
HIGH POWER	SQUELCH			

- Switches to edit DSC scanning table
- Switches to previous scanning type
- Switches to next scanning type
- Returns to previous telephony setting

Scanning rate is approx. six channels per 2 sec.

DSC Functions

DSC Main Buttons



Opens a menu to the call log where all DSC calls are stored. In this menu transmitted calls, received distress calls and other received calls sorted by time can be read separately. Received calls are deleted after 48 hours.



Opens DSC transmitter menu. From here it is possible to make routine calls (SHORE, SHIP) and special calls including distress, urgency and safety calls (EXTENDED).



Opens the address book menu. An address book call is a complete DSC call given a name. Its possible to transmit, add or delete calls.

DSC Status Display



Switches between Telephony display and DSC display. To show DSC Status display if LOG, CALL or BOOK is operated, press CANCEL.

DSC STATUS	UTC 9:47	21 SEP
N 56°00	E 12°00	UTC 9:47
AUTO ACK = ON	AUTO POS = ON	AUTO
DISTRESS FREQUENCY 2187,5 kHz		CANCEL

- ◀ To set real time clock if no GPS time and date
- ◀ To manually enter position if no GPS position
- ◀ To set automatic answer back mode
- ◀ Returns to Telephony display

TIME and POS softkeys disappear when information is updated via the NMEA interface. If not updated via the NMEA interface UTC time and date must be set manually each time the equipment is switched on.

An alarm is given if position data is not received via the NMEA interface for 5 minutes. In this case position information must be entered manually. In case of manual input an alarm is given when the position information is more than 4 hours old. Any position information is deleted if not updated for 23½ hours.

Set answer back mode

Press AUTO softkey:

SET AUTO REPLY		OK
AUTO ACKNOWLEDGEMENT	= ON	ACK
AUTO POSITION RESPONSE	= ON	POS
		CANCEL

- ◀ Enters the setting and returns to Status Display
- ◀ Switches between ON and OFF
- ◀ Switches between ON and OFF
- ◀ Returns to previous Status Display

AUTO ACKNOWLEDGEMENT = ON:

Transmission of acknowledgement is initiated automatically when a direct dial, polling or position request* call is received.

AUTO ACKNOWLEDGEMENT = OFF:

Manuel acknowledgement only. Direct dial calls initiated by the ship can be carried through; direct dial calls from coast stations cannot.

Note: The purpose is to enable the user to prevent automatic transmissions, e.g. when the ship is in port.

AUTO POSITION RESPONSE = ON:

Position information is included in direct dial calls and position request acknowledgements

AUTO POSITION RESPONSE = OFF:

Position information is excluded in direct dial calls and position request acknowledgements

Note: The purpose is to enable the user to prevent *automatic* transmission of the ship's position. Does not influence distress calls.

Receiving a Distress Call

The DSC Watch Receiver keeps continuous watch the distress and safety frequency 2187.5 kHz.

Reception of a distress or urgency call is indicated by a specific sound signal which continues until a key is pressed. The Call and Alarm lamp flashes until the call is read out.

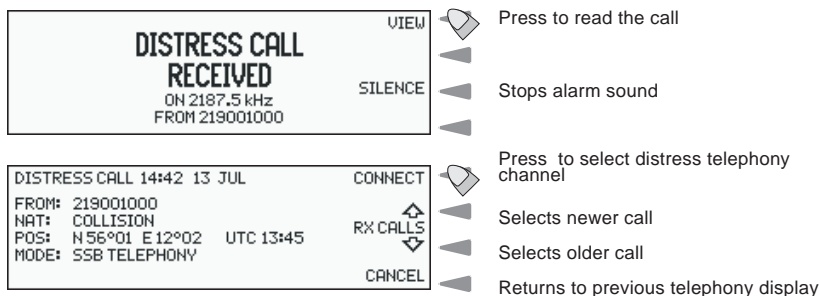

Ships receiving a distress alert from another ship should prepare for receiving the subsequent distress communication on the telephony distress frequency in the same band in which the DSC call was received.

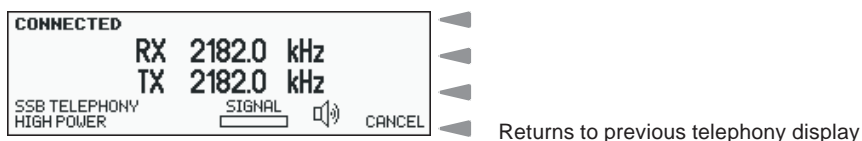

Wait for a short interval in order to give a coast station time to acknowledge the DSC distress alert first. Then, if within range and able to assist, acknowledge the receipt of the distress alert by radiotelephony:

Press the handset key and say:

- "MAYDAY"
- the 9-digit identity of the ship in distress, repeated 3 times
- "This is"
- the 9-digit identity or the call sign or name of own ship, repeated 3 times
- "RECEIVED MAYDAY".

Receiving an All Ships Call

DSC on distress calling frequencies are used by coast stations to advise shipping and by ships to advise coast stations and other ships of a following urgency or safety message. Reception of a safety call addressed to all ships is indicated by a sound signal of 3 seconds duration and a Call lamp that flashes until the call is acted upon. The call alarm sound level setting can be changed, see the Function Menu.

ALL SHIPS CALL RECEIVED ON 2187.5 kHz FROM 002190010	VIEW	◀	Displays the contents of the call
	CONNECT	◀	Press CONNECT to set receiver to the frequency indicated in the call
	CANCEL	◀	Returns to previous telephony display

If VIEW is pressed:

ALL SHIPS CALL 14:29 13 JUL CATEGORY: SAFETY FROM: 002190010 MODE: SSB TELEPHONY WORK: RX 2182.0 kHz	CONNECT	◀	Press CONNECT to set receiver to the frequency indicated in the call
	RX CALLS	◀	Selects older call
	CANCEL	◀	Returns to previous telephony display
	(Up/Down arrows)	◀	

CONNECT is shown if SSB telephony and a legal frequency are indicated in the call and disappears 5 minutes after receipt of the call.

Ships receiving a DSC call to all ships shall not acknowledge the receipt of the call but should set the receiver to the radiotelephony frequency indicated in the call and listen to the urgency or safety message.

CONNECTED RX 2182.0 kHz TX 2182.0 kHz SSB TELEPHONY HIGH POWER	SIGNAL	◀	
	(Speaker icon)	◀	
	CANCEL	◀	Returns to previous telephony display
	(Volume icon)	◀	

Receiving an Individual Call

When the transceiver is not used for traffic, scanning should be activated to keep watch on one or more DSC frequencies used for public correspondence and general ship-to-ship communication.

Reception of an individual routine call addressed to the ship is indicated by a flashing Call lamp and a sound signal which continues until the call is acted upon. The call alarm sound level setting can be changed, see the Function Menu.

LIFT HANDSET TO ACKNOWLEDGE INDIVIDUAL CALL RECEIVED ON 2177.0 kHz FROM 219001000	VIEW	◀	Displays the contents of the call
	ACK	◀	Press ACK or lift handset
	SILENCE	◀	Stops alarm sound
	(Up/Down arrows)	◀	

The call should be answered by sending a DSC Acknowledgement within 4½ minutes. **LIFT HANDSET TO ACKNOWLEDGE** and **ACK** is shown if *SSB telephony* and legal frequencies are indicated in the call. Lifting the handset or pressing the softkey in this case

will initiate transmission of an acknowledgement containing the mode and frequencies from the received call.



Stops transmission and returns to the previous display

Transmission of the DSC acknowledgement takes approx. 8 seconds. Then the equipment is automatically set to the mode and working frequencies from the acknowledgement, and voice communication can start.



Returns to previous telephony display

When handset is placed on hook the equipment returns to previous telephony setting.

Direct Dial Calls:

Some coast stations provide automatic connection from the public switched telephone network allowing a telephone subscriber to call the ship directly without operator intervention at the coast station.

Note: Auto Acknowledgement must be On to allow automatic connection, see DSC Status Display.

An acknowledgement is initiated immediately when a Direct Dial call is received. The handset should be lifted off hook within 1 minute which will initiate a DSC call on the working frequency. This call is used by the coast station for channel quality evaluation. When acknowledgement is received telephone conversation can start.

When the handset is placed on hook after a Direct Dial call a DSC call indicating 'End of call' is sent to terminate the connection.

The coast station may respond with a DSCall indicating the chargeable duration of the connection.

Sending a Test Call

This call type is intended for test of the DSC system on distress and safety frequencies. Press

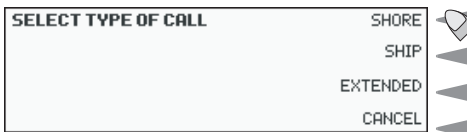

Select SHORE call types

SELECT SHORE CALL	WITH PHONE NO
	WITHOUT NO
	TEST CALL
	CANCEL

- ◀
- ◀
- ◀ Select SAFETY category and TEST call type.
- ◀

Key in the nine digit MMSI number of the nearest coast station which can accept and reply to DSC test calls.

ENTER MMSI NUMBER	OK
TYPE: INDIVIDUAL SAFETY CALL	RECALL
TO: 002191000	◀
	CANCEL

- ◀ Insert the number in the call
- ◀ Selects a submenu where a pre-programmed coast station can be selected
- ◀ Backspace, deletes last figure
- ◀

SELECT DSC FREQUENCY	OK
RX 2187.5 kHz	◀
TX 2187.5 kHz	FREQ
	◀
	CANCEL

- ◀ Select the DSC frequency
- ◀ Steps between DSC distress frequencies
- ◀

SELECT SEND TO TRANSMIT	SEND
TYPE: INDIVIDUAL SAFETY CALL	◀
TO: 002191000	◀
MODE: TEST	◀
	CANCEL

- ◀ Start transmission of the call
- ◀
- ◀
- ◀

Transmission of a DSC call on MF/HF takes approx. 8 seconds. The coast station should answer the call by sending a DSC Acknowledgement within 4½ minutes. No further communication is intended to take place.

ACKNOWLEDGEMENT RECEIVED	VIEW
ON 2187.5 kHz	◀
FROM 002190010	SILENCE
	◀
	CANCEL

- ◀ Display the contents of the acknowledgement
- ◀ Stops alarm sound
- ◀ Returns to telephony display

Calling a Ship

Press Call button



SELECT TYPE OF CALL	SHORE
	SHIP
	EXTENDED
	CANCEL

- ◀
- ◀ Select routine type SHIP call
- ◀
- ◀

Key in the nine digit MMSI number of the wanted ship.

ENTER MMSI NUMBER	OK		Insert the number in the call
TYPE: INDIVIDUAL ROUTINE CALL	RECALL		Selects a submenu where a preprogrammed ship station can be selected
TO: 219001000			Backspace, deletes last figure
	CANCEL		

A working channel shall be proposed when calling another ship.

ENTER WORKING FREQUENCY	OK		Insert the working frequencies in the call
TYPE: INDIVIDUAL ROUTINE CALL	CHANGE		Selects telephony display for change of working frequencies
TO: 219001000			
MODE: SSB TELEPHONY			
WORK: RX 3550.0 TX 3550.0 kHz	CANCEL		

SELECT DSC FREQUENCY	OK		Select the DSC frequency
RX 2177.0kHz			Steps between DSC frequencies
TX 2177.0kHz	FREQ		
	CANCEL		

Normally 2177 kHz is used for intership DSC calls. In addition user programmed DSC frequencies may be selected. If DSC frequencies were selected from the Telephony display prior to the call these are default. Distress frequencies cannot be selected in any way.

SELECT SEND TO TRANSMIT	SEND		Starts transmission of the call
TYPE: INDIVIDUAL ROUTINE CALL			
TO: 219001000			
MODE: SSB TELEPHONY			
WORK: RX 3550.0 TX 3550.0 kHz	CANCEL		

Transmission of a DSC call on MF/HF takes approx. 8 seconds. The called ship is supposed to answer the call by sending a DSC Acknowledgement within 4½ minutes. When acknowledgement is received lift the handset and mode and working frequencies will be set as indicated in the acknowledgement.

LIFT HANDSET TO CONNECT	VIEW		Displays the contents of the acknowledgement
ACKNOWLEDGEMENT RECEIVED	CONNECT		Sets mode and frequency as indicated in the acknowledgement
ON 2177.0 kHz	SILENCE		
FROM 219001000	CANCEL		

If no acknowledgement is received within 5 minutes, the equipment returns to the previous telephony display and starts scanning if selected.

Calling a Coast Station

Press Call button



SELECT TYPE OF CALL	SHORE	
	SHIP	
	EXTENDED	
	CANCEL	

Select SHORE call types

Some coast stations provide automatic connection with the public switched telephone network.

To use this facility select PHONE NO and key in the telephone number. Otherwise:

SELECT SHORE CALL	WITH PHONE NO	
	WITHOUT NO	
	TEST CALL	
	CANCEL	

Select individual routine call type

Key in the nine digit MMSI number of the wanted coast station.

ENTER MMSI NUMBER	OK	
	RECALL	
	CANCEL	
TYPE: INDIVIDUAL ROUTINE CALL		
TO: 002191000		

Insert the number in the call

Selects a submenu where a pre-programmed coast station can be selected

Backspace, deletes last figure

SELECT DSC FREQUENCY	OK	
	FREQ	
RX 1624.5 kHz		
TX 2159.5 kHz		
CANCEL		

Select the DSC frequency

Steps between DSC frequencies

If the MMSI number is found in the station list, the frequencies are selected from the DSC frequencies of the station if any; otherwise from the list of non distress DSC frequencies. If DSC frequencies were selected from the Telephony display prior to the call these are default. Distress frequencies cannot be selected in any way.

SELECT SEND TO TRANSMIT	SEND	
	CANCEL	
TYPE: INDIVIDUAL ROUTINE CALL		
TO: 219001000		
MODE: SSB TELEPHONY		

Start transmission of the call.

Transmission of a DSC call on MF/HF takes approx. 8 seconds. The Coast station if able to

comply will answer the call within 4½ minutes by sending a DSC Acknowledgement containing information on working frequencies for the subsequent traffic. When acknowledgement is received lift the handset to set the radio to the working frequencies.



Displays the contents of the acknowledgement
Sets mode and frequency as indicated in the acknowledgement

If no acknowledgement is received within 5 minutes, the equipment returns to the previous telephony display and starts scanning if selected.

Direct Dial Calls:

If phone a number was included in the call then immediately after reception of the acknowledgement the DSC call is repeated on the working frequency. This call may be used by the coast station for channel quality evaluation. If the channel quality evaluation indicates that communication will be satisfactory, the coast station sends a DSC acknowledgement and starts dialing the subscriber number. Dialing tones may be heard in the speaker or handset.

When the handset is placed on hook after a Direct Dial call a DSC call indicating 'End of call' is sent to terminate the connection.

The coast station may respond with a DSC call indicating the chargeable duration of the connection.

Sending an All Ships Call

This call type is used for announcing a vital safety or urgency message.

Press Call button



Select EXTENDED call menu

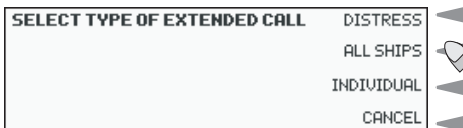

Select ALL SHIPS format

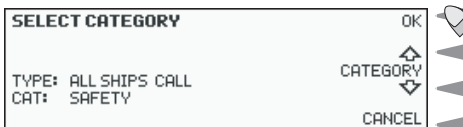

Selects the category

Steps between selectable categories

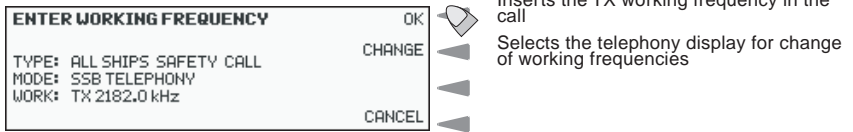
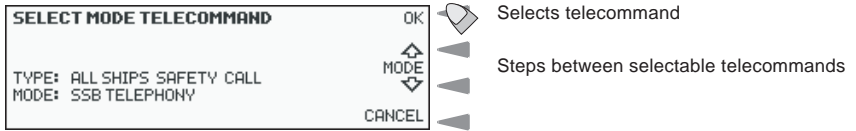

The working frequency for safety calls is normally the distress and safety frequency in the same band as the DSC call, i.e. 2182 kHz on MF.

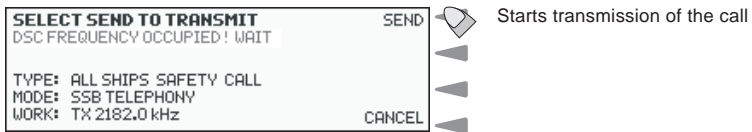
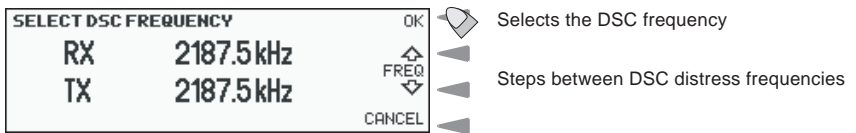

When transmission ceases the equipment is set to SSB telephony and the working frequencies indicated in the call.

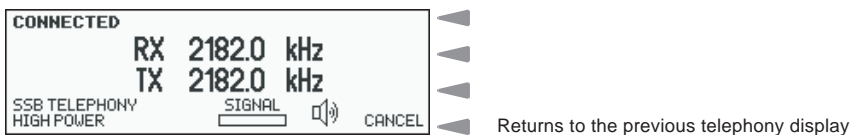

Transmit the safety message as follows:

- "SECURITE", repeated 3 times
- "ALL STATIONS", repeated 3 times
- "this is",
- the 9-digit identity *and* the call sign or name of own ship,
- the text of the safety message

Returns to the previous telephony setting, by an off-to-on hook transition.

Repeat a Call

Press LOG button



DSC LOG	RX DISTRESS	◀	Selects Distress RX call log
	RX OTHER	◀	Selects non-distress RX call log
	TX CALLS	◀	Select TX call log
	CANCEL	◀	Returns to Telephony display

TX call:

ALL SHIPS CALL 13:54 17 JUL CATEGORY: SAFETY MODE: SSB TELEPHONY WORK: RX 2182.0 kHz	RE-SEND	◀	Start transmission of the call
	↑	◀	Selects newer call
	↓	◀	Selects older call
	CANCEL	◀	

The TX call log has capacity for storing 20 transmitted calls. The oldest call is deleted when the capacity is exceeded.

RE-SEND does not appear for acknowledgement calls and distress format and category calls.

TX Call Menu

Menu									
SHORE	WITH PHONE NO		Address	Phone no	DSC freq				
	WITHOUT NO		Address	DSC freq					
	TEST CALL		Address	DSC freq					
SHIP			Address	Working freq	DSC freq				
EXTENDED	DISTRESS	ALERT		Nature of distress*	Position + Time		DSC freq		
		RELAY	ALL SHIPS	Ship in distress	Nature of distress*	Position + Time		DSC freq	
			SHORE	Address	Ship in distress	Nature of distress*	Position + Time	DSC freq	
	ACK		The contents of the last received or transmitted distress alert are inserted in the distress acknowledgement call						
	ALL SHIPS	DISTRESS URGENCY SAFETY	SSB TELEPHONY NO INFORMATION	Working frequency	DSC freq				
INDIVIDUAL	Address	DISTRESS URGENCY SAFETY ROUTINE	SSB TELEPHONY UNABLE TO COMPLY NO INFORMATION	NO INFORMATION POSITION	DSC freq				
			POLLING POSITION REQUEST			DSC freq			

* Nature of distress:

FIRE, EXPLOSION, FLOODING, COLLISION, GROUNDING, DANGER OF CAPSIZING, SINKING, DISABLED AND ADRIFT, UNDESIGNATED (default),
 ABANDONING SHIP, PIRACY, MAN OVERBOARD, EPIRB EMISSION (Distress Relay only)

Changing a Function

There is a number of special functions available as shown in the function menu (this page). To change a function, e.g. display contrast:

Press FUNC button



Select SETTINGS



Select CONTRAST

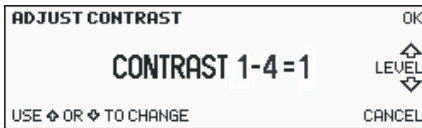

Return to Telephony display



Changes contrast level



Selects previous display

The Function Menu

Menu	1st submenu	2nd submenu	Parameters
SETTINGS	CONTRAST		Contrast setting 1 to 4 (max.)
	RECEPTION	EARPIECE	Level setting 0 to 7 (max.); 0 = follows speaker
		RECEIVER	Treble Cut , Suppressor, Antenna Amplifier
		CALL ALARM	Call Alarm setting 0 to 7
	OPTIONS		Code protected. For authorized service personnel only. See Technical Manual.
STATIONS	Select station/ new station EDIT	CHANNEL	Select channel/new channel EDIT
		NAME & MMSI	Edit name and MMSI
		DELETE	Delete station
INFO & TEST	INFORMATION	MMSI	Display Self-ID and Group IDs of the equipment Change Group-ID
		VERSIONS	Display SW and HW versions
		ALARMS	Display active alarms
	CHECK	TX PROTECTION	Display Protection Code numbers and text
		INTERFACE	SOUND & DISPLAY, ALARM PANEL, NMEA INPUT
		SELFTEST	Self-test numbers, text and result of self-test. REPEAT after stop on error. MANUAL.
	MONITOR	POWER	Display supply voltage and transmitter output power.
		FREQUENCY	Display frequency error for Master Oscillator adjust
		WR AUDIO	Monitor DSC WR audio

Installation

Compass safe distance

Compass safe distance in accordance with ISO/R 694 are given below in metres.

Unit	Standard	Steering
Control Unit	5.4°/H	18°/H
Handset	1.2	0.5
Cradle	0.3	0.2
Cradle	1.1	0.7
LS4970 Loudspeaker	2.2	1.6

Dimensions and weights

Handset

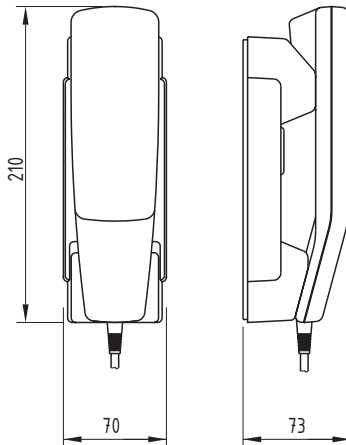

37921

Drilling Plan

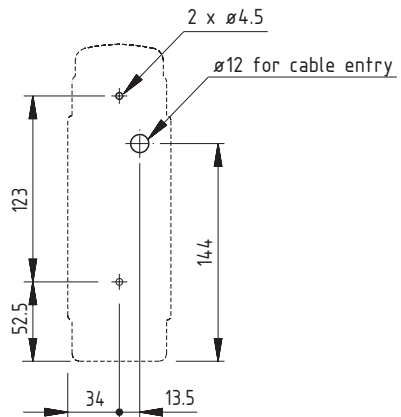

Weight:

Handset 0.5 kg.

Control Unit

The Control Unit may be tabletop or bulkhead mounted.

Control Unit with Mounting Bracket

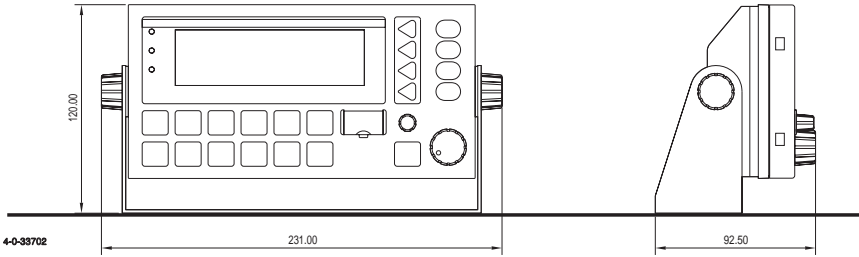

Mounting Option

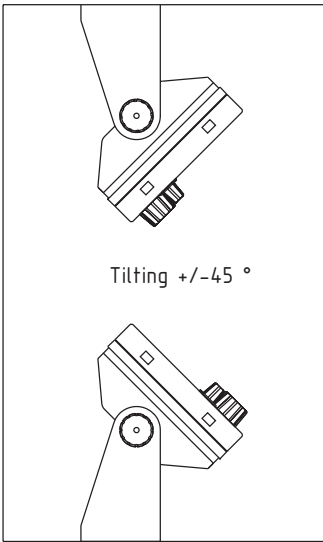

38006

Weight:

Control Unit 1 kg.
Mounting Bracket 0.3 kg.

Drilling Plan

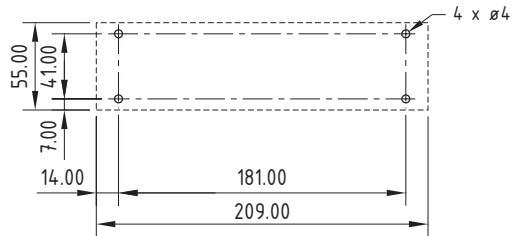

Control Unit connector panel

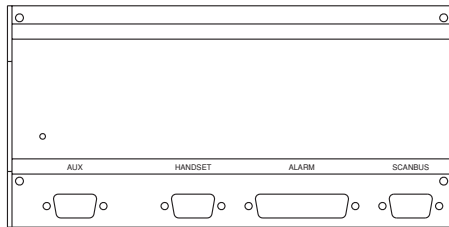

38005

Spare parts list:**NAME****PART NO.**

HC4500B MH/HF Control Unit, green

82450000

HC4500B MH/HF Control Unit, black

82450001

HA4615 Aerial Coupler

80461503

PA and Filters with SMPS Module

738090

Accessory list:

PS4655 AC Power Supply

80465511

CH4656 Battery Charger

80465611

LS4970 External 5W speaker

80497010

CB4616 SUBD-9 to Terminal Block Converter

80461601

CB4618 Handset Connection Box

80461801



SAILOR® · Porsvej 2 · PO Box 7071 · DK-9200 Aalborg SV · Denmark
Phone: +45 9634 6100 · Fax: +45 9634 6101 · Telex: 69789 ECI DK
E-mail: sailor@sailor.dk · Web: www.sailor.dk