

PRICE \$2.00

HEATH COMPANY
BENTON HARBOR, MICHIGAN

HEATHKIT® ASSEMBLY MANUAL

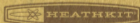
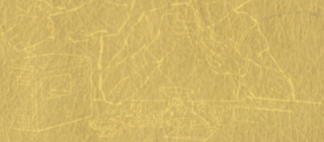

TRANSISTOR-DIODE CHECKER
MODEL IT-27

Copyright © 1967
Heath Company
All rights reserved

STANDARD COLOR CODE — RESISTORS AND CAPACITORS

AXIAL LEAD RESISTOR

Brown — Insulated
Black — Non-insulated

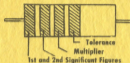

Wire wound resistors have
1st digit band double width

INSULATED
UNINSULATED
Color

BLACK
BROWN
RED
ORANGE
YELLOW
GREEN
BLUE
VIOLET
GRAY
WHITE

FIRST RING
BODY COLOR
First Figure

0
1
2
3
4
5
6
7
8
9

SECOND RING
END COLOR
Second Figure

0
1
2
3
4
5
6
7
8
9

THIRD RING
DOT COLOR
Multiplier

None
0
00
,000
0,000
00,000
000,000
0,000,000
00,000,000
000,000,000

DISC CERAMIC RMA CODE

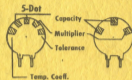

RADIAL LEAD DOT RESISTOR

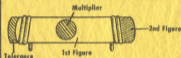

5-DOT RADIAL LEAD CERAMIC CAPACITOR

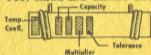

EXTENDED RANGE TC CERAMIC HICAP

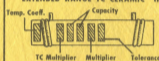

RADIAL LEAD (BAND) RESISTOR

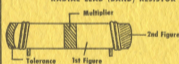

BY-PASS COUPLING CERAMIC CAPACITOR



AXIAL LEAD CERAMIC CAPACITOR



The standard color code provides all necessary information required to properly identify color coded resistors and capacitors. Refer to the color code for numerical values and the zeroes or multipliers assigned to the colors used. A fourth color band on resistors determines tolerance rating as follows: Gold = 5%, silver = 10%. Absence of the fourth band indicates a 20% tolerance rating.

The physical size of carbon resistors is determined by their wattage rating. Carbon resistors most commonly used in Heath-kits are $\frac{1}{2}$ watt. Higher wattage rated resistors when specified are progressively larger in physical size. Small wire wound resistors $\frac{1}{2}$ watt, 1 or 2 watt may be color coded but the first band will be double width.

Assembly and Operation
of the

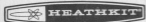

TRANSISTOR-DIODE CHECKER

MODEL IT-27



HEATH COMPANY
BENTON HARBOR, MICHIGAN

TABLE OF CONTENTS

Specifications.	2
Introduction.	3
Schematic.	4
Theory of Operation.	4
Construction Notes.	7
Parts List.	9
Proper Soldering Techniques.	10
Wiring And Soldering.	12
Step-By-Step Procedure.	14
Step-By-Step Assembly.	15
Operation.	23
In Case of Difficulty.	26
Service Information.	27
Service.	27
Replacements.	29
Shipping Instructions.	30
Replacement Parts Price List.	31

SPECIFICATIONS

Tests:	Transistors for: leakage, gain, shorts, and opens. Diodes for: forward and reverse current. Can be used as a continuity tester.
Switches:	FOR-REV/PNP-NPN, DIODE/HI-LO, LEAKAGE-GAIN.
Power Supply:	Self-contained, two 1.5 volt, size C cells.
Net Weight:	12 oz.

The Heath Company reserves the right to discontinue instruments and to change specifications at any time without incurring any obligation to incorporate new features in instruments previously sold.

INTRODUCTION

The HEATHKIT Model IT-27 Transistor-Diode Checker is designed to check transistors for leakage and gain, and to check diodes for forward and reverse current.

Due to the common use of transistors in radio and television sets, the serviceman is often called on to test transistors in the home. This

checker was designed with compactness in mind and uses a self-contained battery power supply for complete portability. The metal cabinet is constructed so that the checker may be placed in any position without the meter or switches touching the supporting surface. The compactness and light weight of this checker make it an ideal tool box instrument.

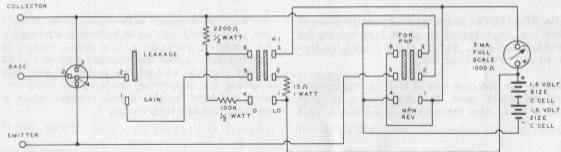

SCHEMATIC OF THE
HEATHKIT[®]
TRANSISTOR-DIODE CHECKER
MODEL IT-27

THEORY OF OPERATION

The operation of a vacuum tube is more familiar to most people than that of a transistor. For this reason, the vacuum tube counterpart of the transistor circuit will be used as an aid in this description. The circuit shown in Figure 1, with the exception of the triode tube, is similar to the circuit of this checker.

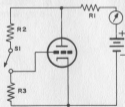

Figure 1

The battery provides a source of plate voltage, and causes plate current to flow through the tube. The value of this current will depend on: (1) the battery voltage, and (2) the circuit impedance, consisting of the tube, the meter movement, resistor R1, and the battery. Except for the tube, all of these impedance values are fixed.

Assume at this time that the current flowing through the tube and meter causes the meter to deflect 10% up-scale. In Figure 1, the grid is returned through R3 to the cathode. This essentially places the grid at cathode potential. By closing switch S1, a voltage divider is formed by R2 and R3, placing a positive voltage on the grid. This causes the current through the tube to increase, raising the meter deflection to 70% or 80% of full scale. Effectively, the tube has been used as a variable impedance to change the current flow in the original circuit. The meter may be considered as an "ohmmeter" since the variation in meter deflection is a direct result of the change in the impedance of the tube. This circuit could be used to

indicate the gain, or transconductance, of the tube, since it reflects the change in plate current due to the change in grid voltage.

Removing the tube from the circuit and replacing it with a transistor will result in the circuits shown in Figure 2.

Figure 2

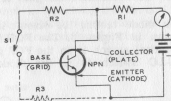

By removing R3 from the circuit, the meter will indicate only the current which is allowed to flow by the series impedance (between emitter and collector terminals) of the transistor. This is called the leakage current, and will be very small if the transistor is functioning properly. Under normal conditions, a good transistor will show little or no leakage current. Closing

switch S1 causes the same reaction as in the previous case where the tube was used; the base voltage (grid) is brought nearer to the collector voltage (plate). This causes the impedance of the transistor to be less, thus increasing collector current, with a corresponding increase in meter deflection. The amount of increase in meter deflection indicates the gain of the transistor.

For diode testing the circuit is connected as shown in Figure 3. The FOR-REV (forward-reverse) switch is in the FOR position and the HI-LO switch is in the diode (D) position.

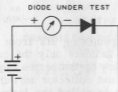

Figure 3

Note that this circuit is also a form of ohmmeter. With the connections shown, the meter will indicate the forward current through the

diode. The forward impedance of the diode is quite low, so the meter reading will be high, approaching full scale deflection in some cases. Moving the FOR-REV switch to the REV position reverses the connections to the diode. This circuit is shown in Figure 4.

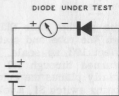

Figure 4

Since the diode presents a high impedance to the reverse current, meter deflection will be correspondingly low. By connecting the diode in this manner and by comparing the forward and reverse currents, the diode can be checked for proper performance of its principal function, which is the ability to pass current freely in one direction while limiting current in the opposite direction.



CONSTRUCTION NOTES

This manual is supplied to assist you in every way to complete your kit with the least possible chance for error. The arrangement shown is the result of extensive experimentation and trial. If followed carefully, the result will be a stable instrument, operating at a high degree of dependability. We suggest that you retain the manual in your files for future reference, both in the use of the instrument and for its maintenance.

UNPACK THE KIT CAREFULLY AND CHECK EACH PART AGAINST THE PARTS LIST. In so doing, you will become acquainted with the parts. Refer to the charts and other information on the inside covers of the manual to help you identify the components. If some shortage or parts damage is found in checking the Parts List, please read the Replacement section and supply the information called for therein.

We suggest that you do the following before work is started:

1. Lay out all parts so that they are readily available.
2. Provide yourself with good quality tools. Basic tool requirements consist of a screwdriver with a 1/4" blade; a small screwdriver with a 1/8" blade; long-nose pliers; wire cutters, preferably separate diagonal cutters; a penknife or a tool for stripping insulation from wires; and a soldering iron (or gun). A set of nut drivers and a nut starter, while not necessary, will aid extensively in construction of the kit.

Most kit builders find it helpful to separate the various parts into convenient categories. Muffin tins or molded egg cartons make convenient trays for small parts. Resistors and capacitors may be placed with their lead ends inserted in the edge of a piece of corrugated cardboard until they are needed. Values can be written on the cardboard next to each component. The illustration shows one method that may be used.

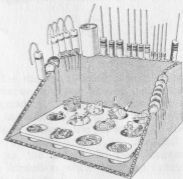

PARTS LIST

<u>PART No.</u>	<u>PARTS Per Kit</u>	<u>DESCRIPTION</u>
RESISTORS		
1-44	1	2200 Ω 1/2 watt (red-red-red)
1-26	1	100 K Ω 1/2 watt (brown-black-yellow)
1-12-1	1	15 Ω 1 watt (brown-green-black)
METAL PARTS		
90-354-1	1	Cabinet bottom
90-355-1	1	Front panel
204-384	1	Battery contact bracket
204-385	1	Battery terminal bracket
205-228	1	Switch plate
HARDWARE		
250-70	6	6-32 x 3/16" screw (flat head)
250-89	9	6-32 x 3/8" screw
250-8	4	#6 sheet metal screw
250-138	2	6-32 x 3/16" screw (binder head)
250-175	2	2-56 x 3/8" screw

<u>PART No.</u>	<u>PARTS Per Kit</u>	<u>DESCRIPTION</u>
Hardware (cont'd.)		
252-3	9	6-32 nut
252-9	3	Push-on speednut
252-22	2	6-32 speednut
252-51	2	2-56 nut
253-1	2	#6 flat fiber washer
253-2	2	#6 shoulder fiber washer
254-1	5	#6 lockwasher
259-1	2	#6 solder lug

MISCELLANEOUS

60-2	2	DPDT slide switch
60-6	1	SPST slide switch, spring return
70-5	3	Banana plug insulator (black)
438-13	3	Banana plug
208-2	2	Battery mounting clip
260-16	3	Alligator clip
261-29	4	Rubber foot
341-1	1	Length black test lead
344-59	1	Length hookup wire
346-1	1	Length insulating sleeving

<u>PART No.</u>	<u>PARTS Per Kit</u>	<u>DESCRIPTION</u>
Miscellaneous (cont'd.)		
407-71	1	Meter with mounting clip
434-102	1	Transistor socket
436-2	3	Banana jack
437-1	3	Banana jack insert
331-6		Solder
597-260	1	Parts Order Form
597-308	1	Kit Builders Guide

<u>PART No.</u>	<u>PARTS Per Kit</u>	<u>DESCRIPTION</u>
Miscellaneous (cont'd.)		
391-34	1	Blue and white identification label
595-876	1	Manual
Two standard size "C" flashlight batteries should be purchased at this time for use in the completed kit.		

PROPER SOLDERING TECHNIQUES

Only a small percentage of customers find it necessary to return equipment for factory service. By far the largest portion of malfunctions in this equipment are due to poor or improper soldering.

If terminals are bright and clean and free of wax, frayed insulation and other foreign substances, no difficulty will be experienced in soldering. Correctly soldered connections are essential if the performance engineered into a kit is to be

fully realized. If you are a beginner with no experience in soldering, a half hour's practice with some odd lengths of wire may be a worthwhile investment.

For most wiring, a 25 to 100 watt iron or its equivalent in a soldering gun is very satisfactory. A lower wattage iron than this may not heat the connection enough to flow the solder smoothly. Keep the iron tip clean by wiping it from time to time with a cloth.



PARTS PICTORIAL

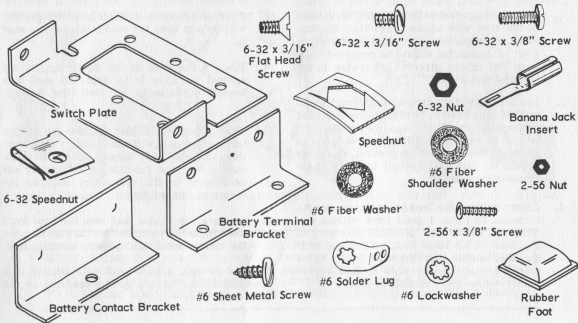

WIRING AND SOLDERING

1. Unless otherwise indicated, all wire used is the type with colored insulation (hookup wire). In preparing a length of hookup wire, 1/4" of insulation should be removed from each end unless directed otherwise in the construction step.
 2. Leads on resistors are generally much longer than they need to be to make the required connections. In these cases, the leads should be cut to proper length before the part is added to the chassis. In general, the leads should be just long enough to reach their terminating points.
 3. Crimp or bend the lead (or leads) around the terminal to form a good joint without relying on solder for physical strength. If the wire is too large to allow bending or if the step states that the wire is not to be crimped, position the wire so that a good solder connection can still be made.
 4. Position the work, if possible, so that gravity will help to keep the solder where you want it.
 5. Place a flat side of the soldering iron tip against the joint to be soldered until it is heated sufficiently to melt the solder.
 6. Then place the solder against the heated terminal and it will immediately flow over the joint; use only enough solder to thoroughly wet the junction. It is usually not necessary to fill the entire hole in the terminal with solder.
 7. Remove the solder and then the iron from the completed junction. Use care not to move the leads until the solder is solidified.
- A poor or cold solder joint will usually look crystalline and have a grainy texture, or the

solder will stand up in a blob and will not have adhered to the joint. Such joints should be reheated until the solder flows smoothly over the

entire junction. In some cases, it may be necessary to add a little more solder to achieve a smooth bright appearance.

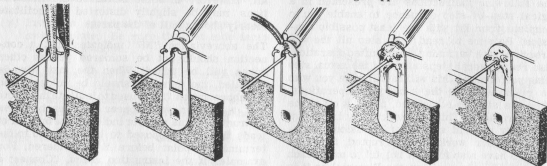

CRIMP WIRES HEAT CONNECTION APPLY SOLDER ALLOW SOLDER TO FLOW PROPER SOLDER CONNECTION

ROSIN CORE SOLDER HAS BEEN SUPPLIED WITH THIS KIT. THIS TYPE OF SOLDER MUST BE USED FOR ALL SOLDERING IN THIS KIT. ALL GUARANTEES ARE VOIDED AND WE WILL NOT REPAIR OR SERVICE EQUIPMENT IN WHICH ACID CORE SOLDER OR PASTE FLUXES HAVE BEEN USED. IF ADDITIONAL SOLDER IS NEEDED, BE SURE TO PURCHASE ROSIN CORE (60:40 or 50:50 TIN-LEAD CONTENT) RADIO TYPE SOLDER.

STEP-BY-STEP PROCEDURE

The following instructions are presented in a logical step-by-step sequence to enable you to complete your kit with the least possible confusion. Be sure to read each step all the way through before beginning the specified operation. Also read several steps ahead of the actual step being performed. This will familiarize you with the relationship of the subsequent operations. When the step is completed, check it off in the space provided. This is particularly important as it may prevent errors or omissions, especially if your work is interrupted. Some kit builders have also found it helpful to mark each lead in colored pencil on the Pictorial as it is added.

In general, the illustrations in this manual correspond to the actual configuration of the

kit; however, in some instances the illustrations may be slightly distorted to facilitate clearly showing all of the parts.

The abbreviation "NS" indicates that a connection should not be soldered yet as other wires will be added. When the last wire is installed, the terminal should be soldered and the abbreviation "S" is used to indicate this. Note that a number will appear after each solder instruction. This number indicates the number of leads that are supposed to be connected to the terminal in point before it is soldered. For example, if the instruction reads, "Connect a lead to lug 1 (S-2)," it will be understood that there will be two leads connected to the terminal at the time it is soldered. (In cases where a lead passes through a terminal or lug and then connects to another point, it will count as two leads, one entering and one leaving the terminal.)

STEP-BY-STEP ASSEMBLY

Refer to Pictorial 1 for the following steps.

- (x) Install a speednut on each flange of the switch plate. Be sure the flat side faces outward as shown.
- (v) Mount switches F, G, and H on the switch plate. Use 6-32 x 3/16" flat head screws. Be sure to place the two lugs of switch H toward the edge of the switch plate as shown.

Refer to Pictorial 2 for the following steps.

- (X) Place the front panel on your work area as shown, and install the switch plate assembly on the front panel. Use 6-32 x 3/8" screws, #6 lockwashers, and 6-32 nuts.
- (v) Mount banana jacks at locations A, B, and C. Use the large push-on speednuts. Refer to Detail 2A.

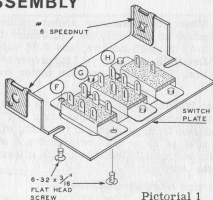

- () Place a banana jack insert into each of the three jacks and bend the lugs as shown in Detail 2A.

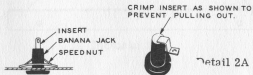

- (X) Connect a 2-1/4" wire from lug 1 of transistor socket E (NS) to lug 5 of switch F (S-1).
- (X) Connect a 3" wire from lug 3 of transistor socket E (NS) to lug 2 of switch F (NS).
- (X) Connect one end of a 3" wire through lug 4 (NS) to lug 2 (S-1) of transistor socket E. Now solder lug 4 (S-2).
- (X) Connect the other end of this wire to lug 2 of switch H (NS).
- (X) Connect a 4-1/4" wire from lug 2 of switch H (S-2) to banana jack C (S-1).
- (X) Connect a 3-1/4" wire from lug 1 of transistor socket E (S-2) to banana jack A (S-1).
- (X) Connect a 3-1/4" wire from lug 3 of transistor socket E (S-2) to banana jack B (S-1).

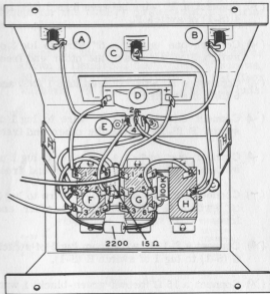

Pictorial 2

- (✓) Connect a 3" wire between lugs 3 (NS) and 4 (S-1) of switch F.
- (✓) Connect one end of a 6" wire to lug 3 of switch F (S-2). Leave the other end free.
- (✓) Connect a 3" wire between lugs 1 (NS) and 6 (NS) of switch F.
- (✓) Connect one end of a 3" wire to lug 1 of switch F (S-2). Leave the other end free.
- (✓) Connect one end of a 6" wire to lug 1 of switch G (NS). Leave the other end free.
- (✓) Connect one end of a 2-1/2" wire to lug 1 of switch G (NS). Leave the other end free.
- (✓) Connect a 2-1/4" wire from lug 5 of switch G (S-1) to lug 1 of switch H (S-1).
- (✓) Connect a 15 Ω (brown-green-black) 1 watt resistor between lugs 1 (S-3) and 2 (S-1) of switch G. Save the clipped off resistor wire for use in a later step.
- (✓) Connect a length of bare wire from lug 3 of switch G (S-1) to lug 6 of switch F (S-2). Use a piece of resistor wire.
- (✓) Connect a 100 K Ω (brown-black-yellow) resistor between lugs 4 (S-1) and 6 (NS) of switch G.
- (✓) Connect a 2200 Ω (red-red-red) resistor from lug 6 of switch G (S-2) to lug 2 of switch F (S-2). Use sleeving.
- (✓) Referring to Detail 2C, install the meter at D by placing the mounting clip under the chassis and then pushing the meter case through both the panel and mounting clip. Be sure that the meter scale is right side up.
- (✓) Connect the shortest wire coming from lug 1 of switch G to the positive (+) terminal of meter D (S-1). CAUTION: Do not overheat the meter terminal as the plastic meter case is easily melted.

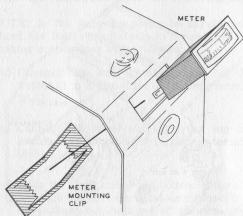

Detail 2C

- (X) Connect the wire coming from lug 1 of switch F to the negative (-) terminal of meter D (S-1).

Except for the battery connections, the wiring is completed.

- (X) Assemble the battery terminal bracket as shown in Detail 3A. Use 6-32 x 3/8" screws, #6 shoulder fiber washers, #6 flat fiber washers, #6 solder lugs, and 6-32 nuts.

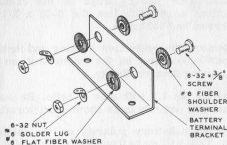

Detail 3A

Refer to Pictorial 3 for the following steps.

- (✓) Mount the battery contact and battery terminal brackets on the cabinet bottom as shown in Pictorial 3. Use 6-32 x 3/8" screws, #6 lockwashers, and 6-32 nuts. Do not tighten the screws holding the battery terminal bracket.
- (✓) Mount the battery clips on the cabinet bottom as shown. Use the 6-32 x 3/16" screws and 6-32 nuts.
- (✓) Remove the protective backing and install four rubber feet on the cabinet bottom by pressing them on firmly.
- (✓) Install the 1.5 volt size C cells. Be sure that cell polarity is as shown in Pictorial 3.

NOTE: Mark battery polarity on the cabinet bottom. This will make it unnecessary to refer to the manual when changing batteries in the future.

- (✓) Push (or pry) the battery terminal bracket tightly against the cells. While holding the battery terminal bracket in place, tighten the two screws securely. Check to see that the batteries are making good contact.

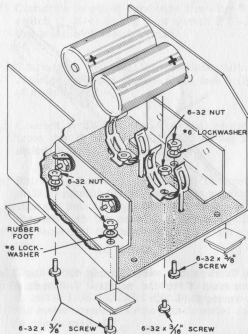

Pictorial 3

Refer to Pictorial 4 for the following steps.

NOTE: In the following steps, be careful not to short the battery terminals to the cabinet when making connections and soldering.

- (X) Connect the wire coming from lug 1 of switch G to the positive (+) battery terminal (S-1).
- (X) Connect the wire coming from lug 3 of switch F to the negative (-) battery terminal (S-1).
- (X) Slide the front panel and bottom of the cabinet together. Secure with four #6 sheet metal screws and two 6-32 x 3/8" screws, one on each side in the dimpled holes. Be careful not to pinch the battery wires.

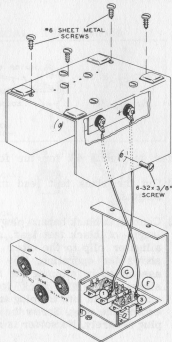

Pictorial 4

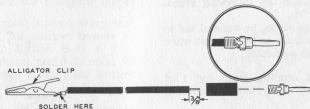

Detail 4A

Refer to Detail 4A for the following steps.

- (✂) Cut the black test lead into three equal lengths.
- (✂) Connect a black banana plug to one end of a length of black test lead, and connect an alligator clip to the other end. Detail 4A shows the operation. The banana plug is assembled by slipping the black insulator sleeve over the black lead. Insert the stripped lead into the plug and wrap it once around the plug. Screw the sleeve onto the plug securely. No solder is required.

- () Similarly, prepare two more test leads with a banana plug on one end and an alligator clip on the other end.
- () Carefully peel away the backing paper from the blue and white identification label. Then press the label onto the inside of the cabinet. Be sure to refer to the numbers on this label in any communications you have with the Heath Company about this kit.

This completes the construction of your Transistor-Diode Checker.

OPERATION

The importance of thoroughly understanding the operation of your Transistor Checker cannot be overemphasized. Testing is performed on a qualitative, rather than quantitative, basis. Interpretation of the meter reading, instead of the reading itself, will be the determining factor in deciding "whether or not to replace." Proper interpretation of the meter indications can come only from using the instrument, and being familiar with its operation.

Carefully study the printing on the front panel to determine which switch positions are used for transistors, and which positions are used when checking diodes.

NOTE: A chart illustrating the lead connections of various types of transistors is provided. If you are in doubt as to the type of transistor to be tested (high power or low power), we suggest that the transistor in question be compared with the chart. An up-to-date transistor manual will provide any detailed information needed.

TYPICAL TRANSISTORS

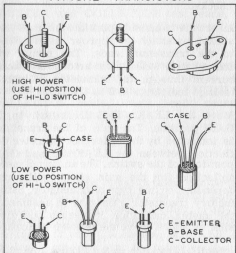

TRANSISTORS

1. Place the PNP-NPN and HI-LO switches in the proper positions for the transistor to be checked.
2. Insert the transistor pins into the transistor socket, or attach the appropriate test leads to the transistor leads. The meter will immediately indicate the amount of leakage current through the transistor. A typical leakage indication is 0 to 1/4 scale.
3. Move the LEAKAGE-GAIN switch to the GAIN position. The gain of the transistor is indicated by the difference in meter deflection between the LEAKAGE and GAIN positions of the switch. The amount of meter deflection for the gain check will vary, depending on the type of transistor. Satisfactory transistor gain may be assumed if the meter indication increases one division or more above the leakage indication.

With the HI-LO switch in the LO position, 3 ma of collector current will cause full-scale meter deflection. In the HI position, approximately

175 ma of collector current will cause full-scale deflection.

The meter reading obtained when checking each transistor should be listed. This list of "expected-readings" will prove helpful when checking the same transistor types in the future.

If a selection of good transistors is available, they may be used to start the list. A blank chart for listing transistor readings is provided on Page 32.

SHORTED TRANSISTORS

A shorted transistor will cause full scale meter deflection during the leakage test.

OPEN TRANSISTOR

An open transistor will cause no meter deflection in either the leakage or gain test.

DIODES

1. Place the HI-LO-D switch in the D position.

2. Connect the EMITTER and COLLECTOR test leads to the diode leads, observing the polarity shown on the front of the checker.
3. Place the FOR-REV switch in the FOR position. A large amount of meter deflection should occur. Place the switch in the REV position. The meter reading should decrease, indicating a large difference between FOR and REV currents.
4. If the diode is shorted there will be no difference in the meter reading as you switch from FOR to REV. If diode is open, there will be no deflection.

NOTE: The amount of deflection obtained with the switch in the FOR position depends on the type of diode being tested. Silicon and germanium diodes have a low resistance, and should provide nearly full-scale deflection. Selenium and copper oxide diodes have a higher resistance, and normally provide approximately half-scale deflection.

CONTINUITY TESTING

The IT-27 can be used as a continuity tester by connecting the circuit to be checked between the EMITTER and COLLECTOR test leads. Continuity will be indicated by full scale deflection of the meter.

CAUTION: The test leads should be removed from the Checker when it is not in use to prevent accidental shorting of the EMITTER and COLLECTOR leads, which would cause the battery cells to discharge.

BATTERY TEST

The batteries used in the checker can be tested by momentarily shorting the EMITTER and COLLECTOR test leads together. Full-scale meter deflection indicates that the two batteries are fresh (3 volts). A reading of 75% full scale (or less) indicates that the batteries should be replaced.

IN CASE OF DIFFICULTY

1. Recheck the wiring. Trace each lead in colored pencil on the Pictorial as it is checked. It is frequently helpful to have a friend check your work. Someone who is not familiar with the unit may notice something consistently overlooked by the constructor.
2. It is interesting to note that about 90% of the kits that are returned for repair, do not function properly due to poor connections and soldering. Therefore, many troubles can be eliminated by reheating all connections to make sure that they are soldered as described in the Proper Soldering Techniques section of this manual.
3. Check the values of the component parts. Be sure that the proper part has been wired into the circuit, as shown in the pictorial diagrams and as called out in the wiring instructions.
4. Check for bits of solder, wire ends or other foreign matter which may be lodged in the wiring beneath the chassis.
5. Make sure that the cells are not weak. Momentarily touch the EMITTER and COLLECTOR test leads together. Full-scale meter deflection indicates full battery voltage (3 volts).

Refer to the Kit Builders Guide for Warranty information.

SERVICE INFORMATION

SERVICE

If, after applying the information contained in this manual and your best efforts, you are still unable to obtain proper performance, it is suggested that you take advantage of the technical facilities which the Heath Company makes available to its customers.

The Technical Consultation Department is maintained for your benefit. This service is available to you at no charge. Its primary purpose is to provide assistance for those who encounter difficulty in the construction, operation or maintenance of HEATHKIT equipment. It is not intended, and is not equipped to function as a general source of technical information involving kit modifications nor anything other than the normal and specified performance of HEATHKIT equipment.

Although the Technical Consultants are familiar with all details of this kit, the effectiveness of their advice will depend entirely upon the amount

and the accuracy of the information furnished by you. In a sense, YOU MUST QUALIFY for GOOD technical advice by helping the consultants to help you. Please use this outline:

1. Before writing, fully investigate each of the hints and suggestions listed in this manual under In Case Of Difficulty. Possibly it will not be necessary to write.
2. When writing, clearly describe the nature of the trouble and mention all associated equipment. Specifically report operating procedures, switch positions, connections to other units and anything else that might help to isolate the cause of trouble.
3. Report fully on the results obtained when testing the unit initially and when following the suggestions under In Case Of Difficulty. Be as specific as possible and include voltage readings if test equipment is available.

4. Identify the kit Model Number and Series Number, and date of purchase, if available. Also mention the date of the kit assembly manual. (Date at bottom of Page 1.)
5. Print or type your name and address, preferably in two places on the letter.

With the preceding information, the consultant will know exactly what kit you have, what you would like it to do for you and the difficulty you wish to correct. The date of purchase tells him whether or not engineering changes have been made since it was shipped to you. He will know what you have done in an effort to locate the cause of trouble and, thereby, avoid repetitious suggestions. In short, he will devote full time to the problem at hand, and through his familiarity with the kit, plus your accurate report, he will be able to give you a complete and helpful answer. If replacement parts are required, they will be shipped to you, subject to the terms of the Warranty.

The Factory Service facilities are also available to you, in case you are not familiar enough with

electronics to provide our consultants with sufficient information on which to base a diagnosis of your difficulty, or in the event that you prefer to have the difficulty corrected in this manner. You may return the completed equipment to the Heath Company for inspection and necessary repairs and adjustments. You will be charged a minimal service fee, plus the price of any additional parts or material required. However, if the completed kit is returned within the Warranty period, parts charges will be governed by the terms of the Warranty. State the date of purchase, if possible.

Local Service by Authorized HEATHKIT Service Centers is also available in some areas and often will be your fastest, most efficient method of obtaining service. HEATHKIT Service Centers will honor the regular 90 day HEATHKIT Parts Warranty on all kits, whether purchased through a dealer or directly from the Heath Company; however, it will be necessary that you verify the purchase date of your kit.

Under the conditions specified in the Warranty, replacement parts are supplied without charge;



however, if the Service Center assists you in locating a defective part (or parts) in your kit, or installs a replacement part for you, you may be charged for this service.

HEATHKIT equipment purchased locally and returned to Heath Company for service must be accompanied by your copy of the dated sales receipt from your authorized HEATHKIT dealer in order to be eligible for parts replacement under the terms of the Warranty.

THIS SERVICE POLICY APPLIES ONLY TO COMPLETED EQUIPMENT CONSTRUCTED IN ACCORDANCE WITH THE INSTRUCTIONS AS STATED IN THE MANUAL. Equipment that has been modified in design will not be accepted for repair. If there is evidence of acid core solder or paste fluxes, the equipment will be returned NOT repaired.

For information regarding modification of HEATHKIT equipment for special applications, it is suggested that you refer to any one or more of the many publications that are available on all phases of electronics. They can be

obtained at or through your local library, as well as at most electronic equipment stores. Although the Heath Company sincerely welcomes all comments and suggestions, it would be impossible to design, test, evaluate and assume responsibility for proposed circuit changes for special purposes. Therefore, such modifications must be made at the discretion of the kit builder, using information available from sources other than the Heath Company.

REPLACEMENTS

Material supplied with HEATHKIT products has been carefully selected to meet design requirements and ordinarily will fulfill its function without difficulty. Occasionally, improper operation can be traced to a faulty component. Should inspection reveal the necessity for replacement, write to the Heath Company and supply all of the following information.

- A. Thoroughly identify the part in question by using the part number and description found in the manual Parts List.

- B. Identify the kit Model Number and Series Number.
- C. Mention date of purchase.
- D. Describe the nature of defect or reason for requesting replacement.

The Heath Company will promptly supply the necessary replacement, PLEASE DO NOT RETURN THE ORIGINAL COMPONENT UNTIL SPECIFICALLY REQUESTED TO DO SO. Do not dismantle the component in question as this will void the guarantee. This replacement policy does not cover the free replacement of parts that may have been broken or damaged through carelessness on the part of the kit builder.

SHIPPING INSTRUCTIONS

In the event that your instrument must be returned for service, these instructions should be carefully followed.

Wrap the equipment in heavy paper, exercising

care to prevent damage. Place the wrapped equipment in a stout carton of such size that at least three inches of shredded paper, excelsior, or other resilient packing material can be placed between all sides of the wrapped equipment and the carton. Close and seal the carton with gummed paper tape, or alternately, tie securely with stout cord. Clearly print the address on the carton as follows:

To: HEATH COMPANY
Benton Harbor, Michigan 49022

ATTACH A LETTER TO THE OUTSIDE OF THE CARTON BEARING YOUR NAME, COMPLETE ADDRESS, DATE OF PURCHASE, AND A BRIEF DESCRIPTION OF THE DIFFICULTY ENCOUNTERED. Also, include your name and return address on the outside of the carton. Preferably affix one or more "Fragile" or "Handle With Care" labels to the carton, or otherwise so mark with a crayon of bright color. Ship by insured parcel post or prepaid express; note that a carrier cannot be held responsible for damage in transit if, in HIS OPINION, the article is inadequately packed for shipment.

REPLACEMENT PARTS PRICE LIST

PART No.	PRICE Each	DESCRIPTION	PART No.	PRICE Each	DESCRIPTION
RESISTORS			MISCELLANEOUS		
1-44	.10	2200 Ω 1/2 watt	60-2	.25	DPDT slide switch
1-26	.10	100 K Ω 1/2 watt	60-6	.35	SPST slide switch, spring return
1-12-1	.10	15 Ω 1 watt	70-5	.10	Banana plug insulator (black)
METAL PARTS			438-13	.20	Banana plug
90-354-1	.60	Cabinet bottom	208-2	.10	Battery mounting clip
90-355-1	.70	Front panel	260-16	.10	Alligator clip
204-384	.10	Battery contact bracket	261-29	.10	Rubber foot
204-385	.10	Battery terminal bracket	341-1	.05/ft	Black test lead
205-228	.25	Switch plate	344-59	.05/ft	Hookup wire
HARDWARE			346-1	.05/ft	Insulating sleeving
250-70	.05	6-32 x 3/16" screw (flat head)	407-71	3.00	Meter with mounting clip
250-89	.05	6-32 x 3/8" screw	434-102	.15	Transistor socket
250-8	.05	#6 sheet metal screw	436-2	.10	Banana jack
250-138	.05	6-32 x 3/16" screw (binder head)	437-1	.10	Banana jack insert
250-175	.05	2-56 x 3/8" screw	331-6	.10	Solder
252-3	.05	6-32 nut	595-876	2.00	Manual
252-9	.05	Push-on speednut	The above prices apply only on purchases from the Heath Company where shipment is to a U.S.A. destination. Selling prices elsewhere in U.S.A. may be slightly higher to offset transportation and local taxes. Outside the U.S.A. parts and service are available from your local Heathkit source and will reflect additional transportation, taxes, duties and rates of exchange.		
252-22	.05	6-32 speednut			
252-51	.05	2-56 nut			
253-1	.05	#6 flat fiber washer			
253-2	.05	#6 shoulder fiber washer			
254-1	.05	#6 lockwasher			
259-1	.05	#6 solder lug			

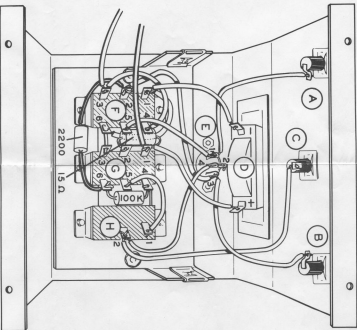

Pictorial 2
PARTS PICTORIAL

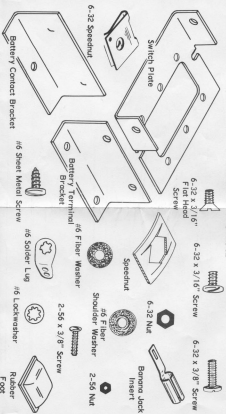

Antenna General		Resistor General		Neon Bulb		Receptacle two-conductor	
Loop		Resistor Tapped		Illuminating Lamp		Battery	
Ground		Resistor Variable		Switch Single pole Single throw		Fuse	
Inductor General		Potentiometer		Switch double pole single throw		Piezoelectric Crystal	
Air core Transformer General		Thermistor		Switch Triple pole Double throw		1000 = K	
Adjustable Powdered Iron Core		Jack two conductor		Switch Multipoint or Rotary		1,000,000 = M	
Magnetic Core Variable Coupling		Jack three conductor		Speaker		OHM = Ω	
Iron Core Transformer		Wires connected		Rectifier		Microfarad = MF	
Capacitor General		Wires Crossing but not connected		Microphone		Micro Microfarad = MMF	
Capacitor Electrolytic		A. Ammeter V. Voltmeter		<p>Typical tube symbol</p>		Binding post Terminal strip	
Capacitor Variable		G. Galvanometer MA. Milliammeter uA. Microammeter, etc.				Wiring between like letters is understood	

HEATH COMPANY

BENTON HARBOR, MICHIGAN

THE WORLD'S FINEST ELECTRONIC EQUIPMENT IN KIT FORM