

4 m

Revised:	Writing for carrying bag no 215-016 4m	Rev:	20-9-75 BC
	Power supply Print B78 D1	Drawn by:	
AP-RADIOTELEFON			Appr'd by: 79096-2E2

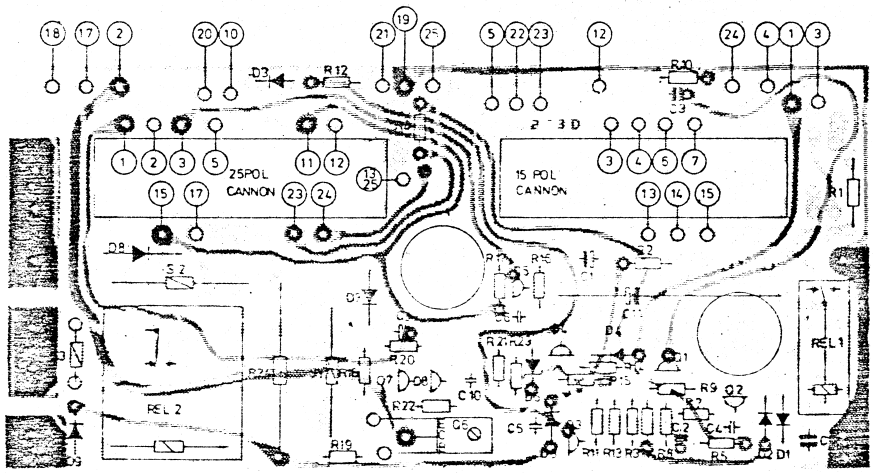

Part No.	Wiring for carrying bag no 215-018 and 215-019 Power supply Print B78 D1	Rev. 1 8-9-78 BC 2C-9-78 LM
	AP-RADIOTELEFON 78	78122-2E2

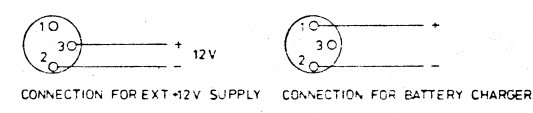
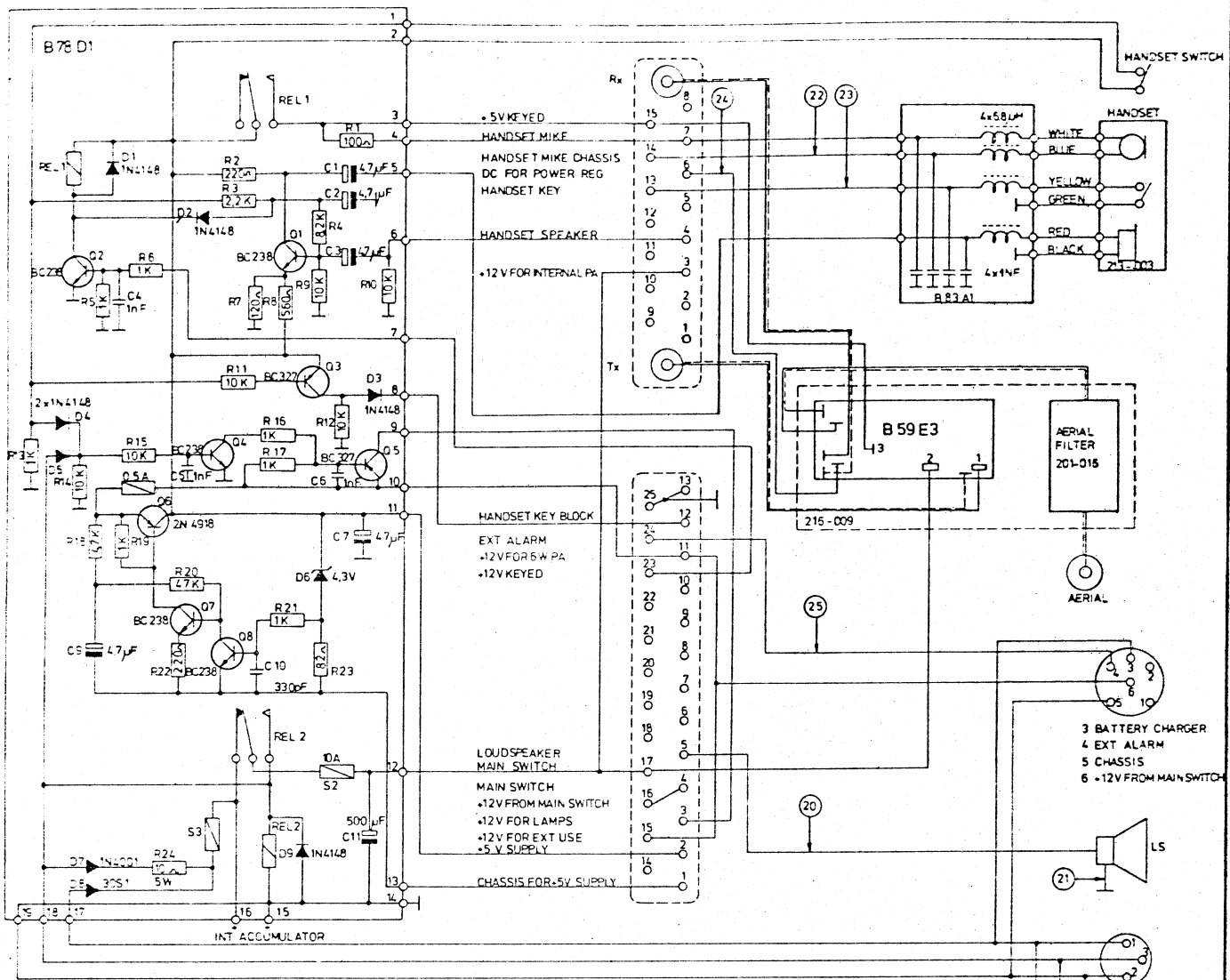
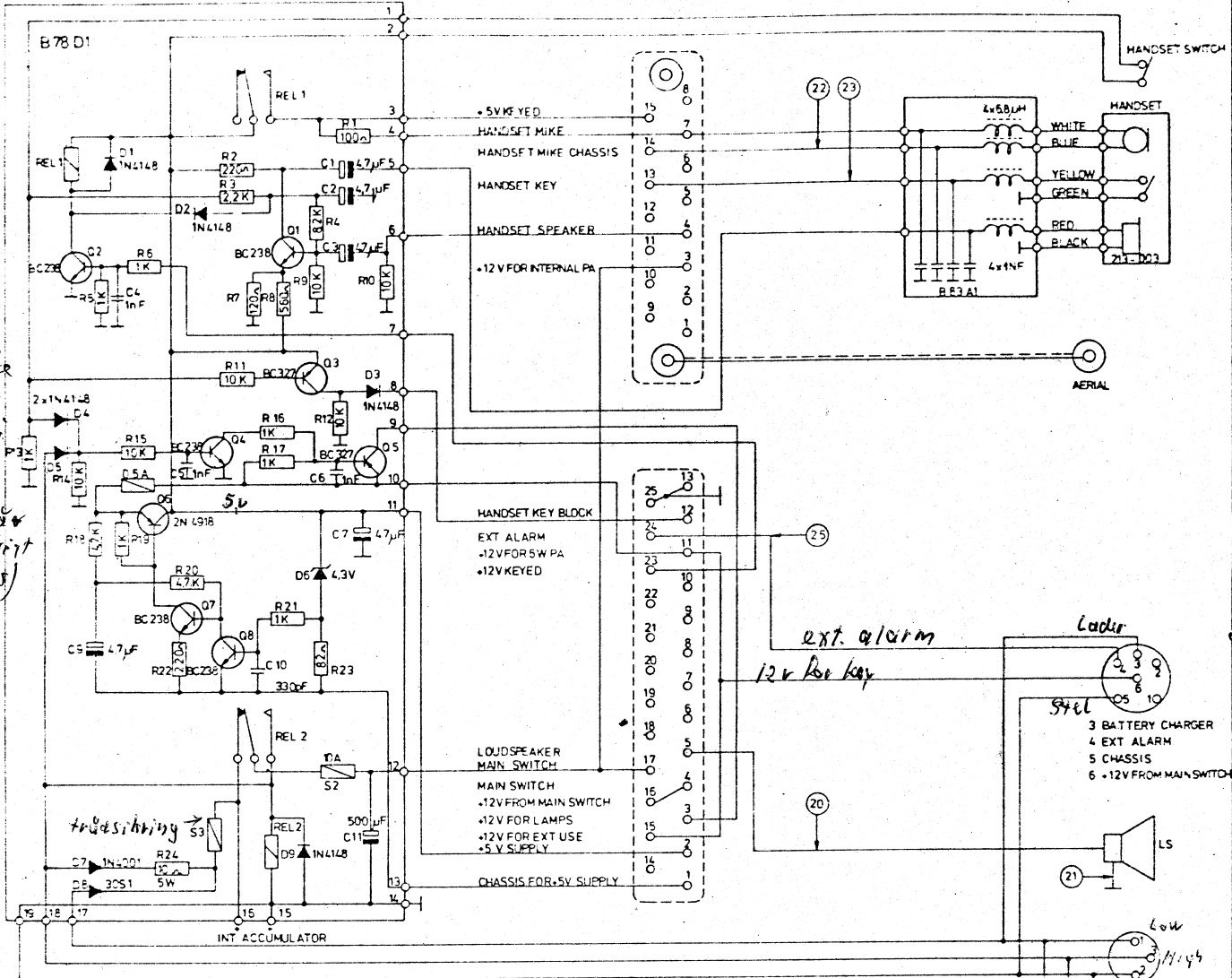

D4 kan lakke
hvortil +5v
bliver for tryk
(gennem hånd-
set switch).
Dette kan på
virke logisk
(R1 og R2)

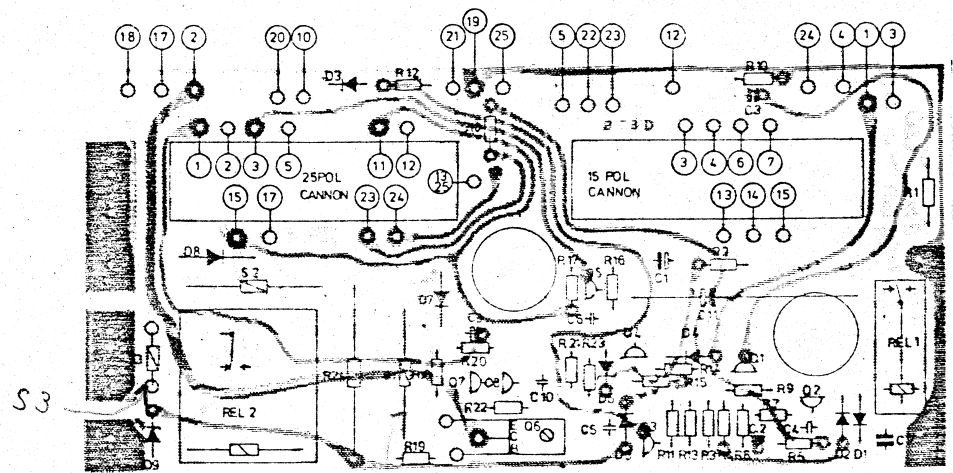
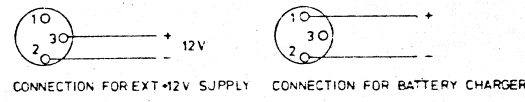

Wiring for carrying bag no 215-015 Power supply Print B 78 D1	1. sign. 1. Komp. 2. 9-78 BC 20-5-78 1M 3. 78123 - 2E2
AP-RADIOTELEFON 78	

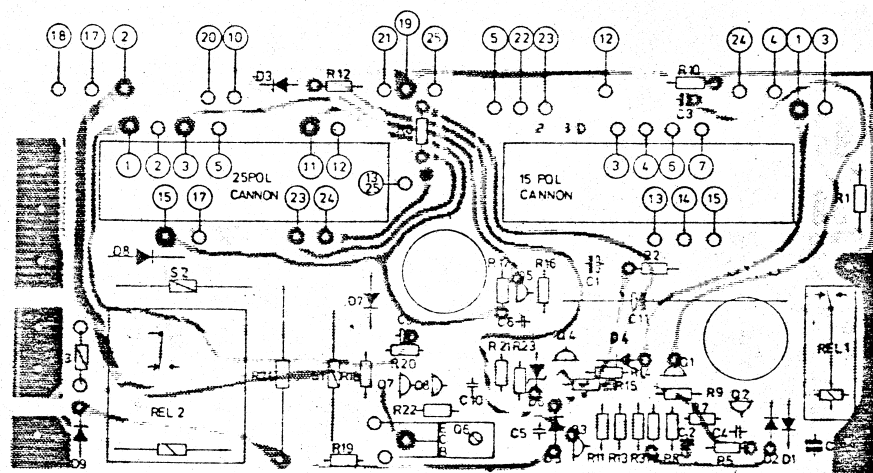
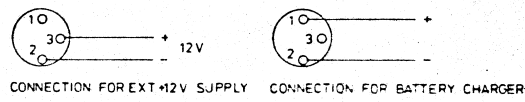
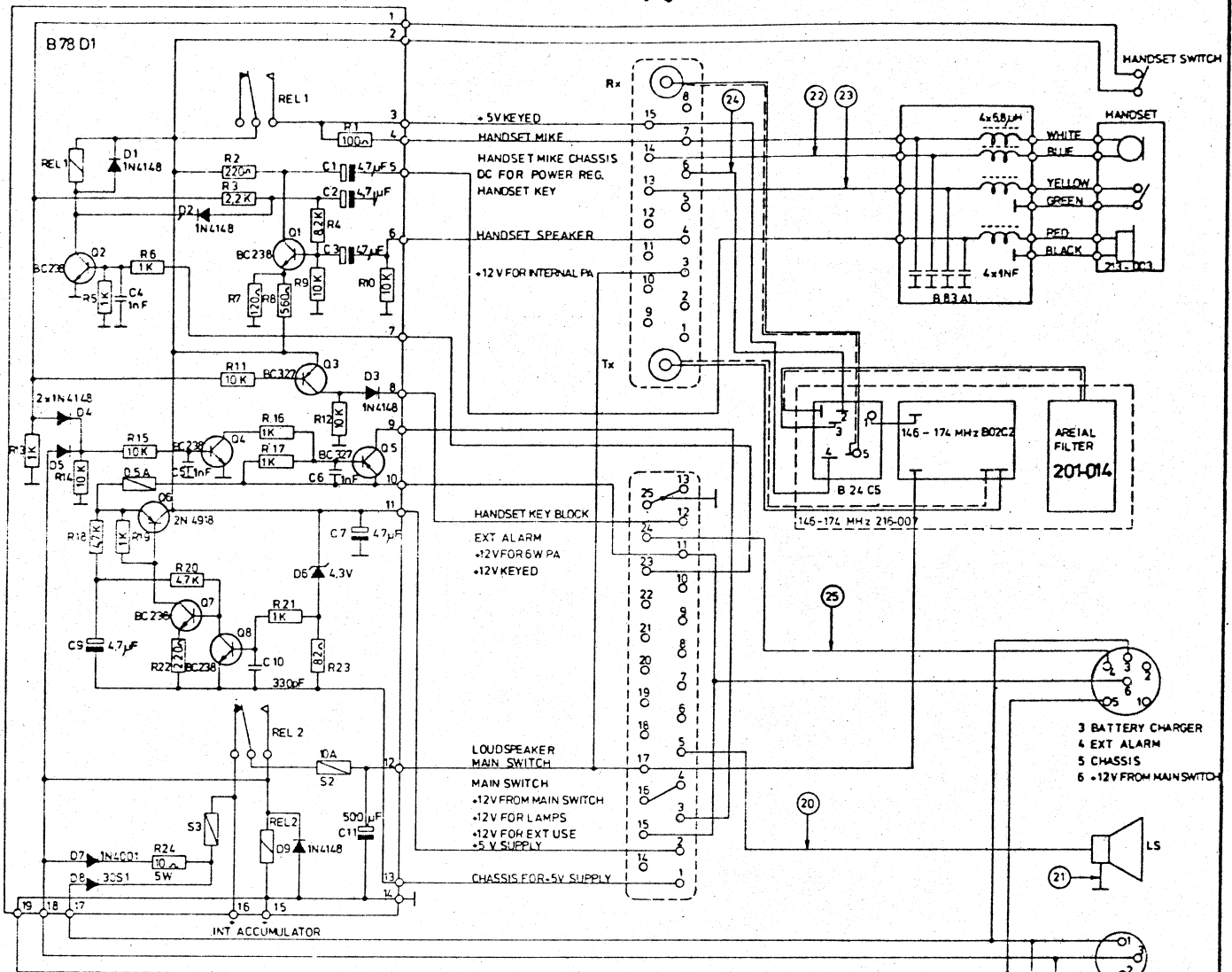

Retent	Wiring for carrying bag no 215-017 2M Power supply Print B78 D1	Techn 18-9-78 BC	Comm 20-9-78 IM
	AP-RADIOTELEFON 46	Sign 78121-2E2	

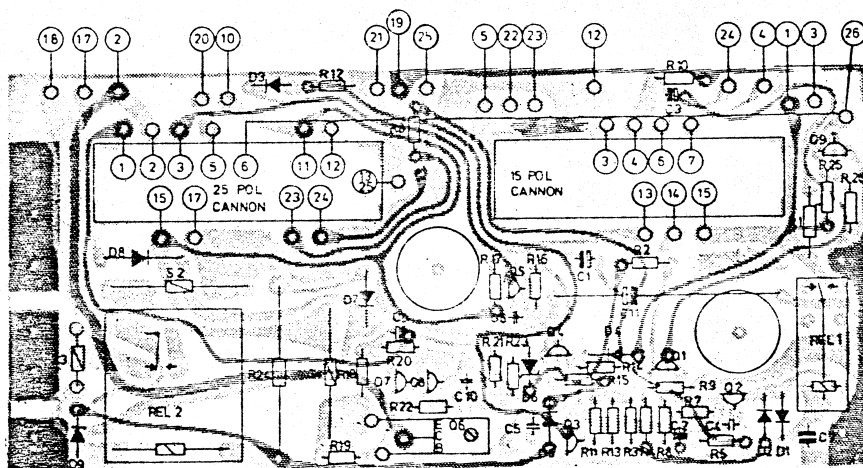
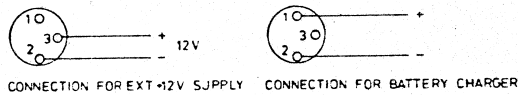
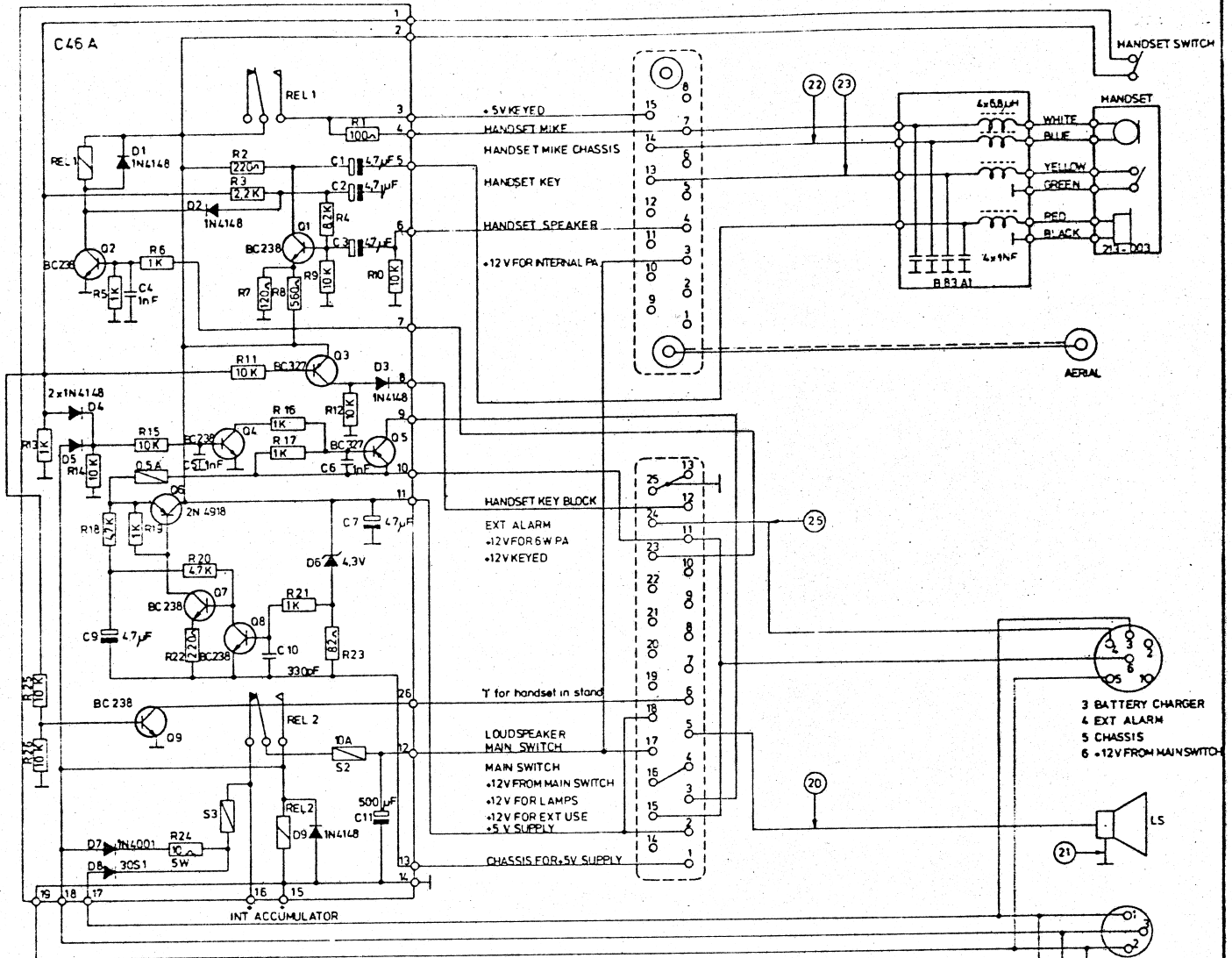

Approved	Wiring for carrying bag no 215-020 Power supply Print C 46 A	Temp	Exam 23 2-75 BJ
		Spec. no	
	AP-RADIOTELEFON 44	Temp. no	79023-2E2

AP-RADIOTELEFON

Nr.	Kode	Data	Nr.	Kode	Data
R1	13-359	100 Ω 1/4W	REL2	17-041	MSK 12 PASI
R2	13-275	220 Ω 1/8W			
R3	13-287	2,2 KΩ "	D1	04-062	1N4148
R4	13-294	8,2 KΩ "	D2	04-062	1N4148
R5	13-283	1 KΩ "	D3	04-062	1N4148
R6	13-283	1 KΩ "	D4	04-062	1N4148
R7	13-272	120 KΩ "	D5	04-062	1N4148
R8	13-280	560 KΩ "	D6	04-045	BZX83-C4V3
R9	13-295	10 KΩ "	D7	04-060	1N4001
R10	13-295	10 KΩ "	D8	04-040	30S1
R11	13-295	10 KΩ "	D9	04-0628	1N4148
R12	13-295	10 KΩ "			
R13	13-283	1 KΩ "	Q1	19-093	BC238B
R14	13-295	10 KΩ "	Q2	19-093	BC238B
R15	13-295	10 KΩ "	Q3	19-095	BC327
R16	13-283	1 KΩ "	Q4	19-093	BC238B
R17	13-283	1 KΩ "	Q5	19-095	BC327
R18	13-291	4,7 KΩ "	Q6	19-176	2N4918
R19	13-283	1 KΩ "	Q7	19-093	BC238B
R20	13-291	4,7 KΩ "	Q8	19-093	BC238B
R21	13-283	1 KΩ "			
R22	13-275	220 Ω "	S1	18-013	0,5 A MT
R23	13-270	82 Ω "	S2	18-014	10 A MT
R24	13-584	10 Ω 5W	S3		0,1 mm kobbertråd
C1	11-505	4,7 μF/25 V Tant			
C2	11-505	4,7 μF/25 V Tant			
C3	11-505	4,7 μF/25 V Tant			
C4	11-409	1 nF Ker			
C5	11-409	1 nF Ker			
C6	11-409	1 nF Ker			
C7	11-509	47 μF/6,3V Tant			
C9	11-505	4,7 μF 25 V Tant			
C10	11-406	330 pF Styr			
C11		500 μF 16 V Tant			
REL1	17-059	RS 6 < V			

Wiring for carrying bag no.
215-018 and 215-019 B 78 D1
Tilhører tegn. nr. 78122-2E2

Rettet:

Tegn.:

Stykl. nr.:

Kontr.:

78122-4S2

AP-RADIOTELEFON

Nr.	Kode	Data	Nr.	Kode	Data
R1	13-359	100 Ω 1/4W	Rel1	17-059	RS 6 V
R2	13-275	220 Ω 1/8W	Rel2	17-041	MSK 12 PASI
R3	13-287	2,2 KΩ "			
R4	13-294	8,2 KΩ "	D1	04-062	1N4148
R5	13-283	1 KΩ "	D2	04-062	1N4148
R6	13-283	1 KΩ "	D3	04-062	1N4148
R7	13-272	120 Ω "	D4	04-062	1N4148
R8	13-280	560 Ω "	D5	04-062	1N4148
R9	13-295	10 KΩ "	D6	04-045	BZX83-C4V3
R10	13-295	10 KΩ "	D7	04-060	1N4001
R11	13-295	10 KΩ "	D8	04-040	30S1
R12	13-295	10 KΩ "	D9	04-0628	1N4148
R13	13-283	1 KΩ "			
R14	13-295	10 KΩ "	Q1	19-093	BC238B
R15	13-295	10 KΩ "	Q2	19-093	BC238B
R16	13-283	1 KΩ "	Q3	19-095	BC327
R17	13-283	1 KΩ "	Q4	19-093	BC238B
R18	13-291	4,7 KΩ "	Q5	19-095	BC237
R19	13-283	1 KΩ "	Q6	19-176	2N4918
R20	13-291	4,7 KΩ "	Q7	19-093	BC238B
R21	13-283	1 KΩ "	Q8	19-093	BC238B
R22	13-275	220 Ω "	Q9	19-093	BC238B
R23	13-270	82 Ω "			
R24	13-584	10 Ω 5W	S1	18-013	0,5 Å MT
R25	13-295	10 KΩ 1/8W	S2	18-014	10 A MT
R26	13-295	10 KΩ "	S3		0,1 mm kobbertråd
C1	11-505	4,7 μF/25 V Tant.			
C2	11-505	4,7 μF/25 V Tant			
C3	11-505	4,7 μF/25 V Tant			
C4	11-409	1 nF Ker			
C5	11-409	1 nF Ker			
C6	11-409	1 nF Ker			
C7	11-509	47 μF/6,3V Tant			
C9	11-505	4,7 μF 25 V Tant			
C10	11-406	330 pF Styr			
C11		500 μF 16 V Tant			
Wiring for carrying bag no. 215-020 Print board C 46 B Tilhører tegn. nr.: 79023-2E2			Rettet:		Tegn.: Kontr.:
					Stykl. nr.: 79023-4S2

AP-RADIOTELEFON

Nr.	Kode	Data	Nr.	Kode	Data
R1	13-359	100 Ω 1/4W	REL2	17-041	MSK 12 PASI
R2	13-275	220 Ω 1/8W			
R3	13-287	2,2 KΩ "	D1	04-062	1N4148
R4	13-294	8,2 KΩ "	D2	04-062	1N4148
R5	13-283	1 KΩ "	D3	04-062	1N4148
R6	13-283	1 KΩ "	D4	04-062	1N4148
R7	13-272	120 KΩ "	D5	04-062	1N4148
R8	13-280	560 KΩ "	D6	04-045	BZX83-C4V3
R9	13-295	10 KΩ "	D7	04-060	1N4001
R10	13-295	10 KΩ "	D8	04-040	30S1
R11	13-295	10 KΩ "	D9	04-0628	1N4148
R12	13-295	10 KΩ "			
R13	13-283	1 KΩ "	Q1	19-093	BC238B
R14	13-295	10 KΩ "	Q2	19-093	BC238B
R15	13-295	10 KΩ "	Q3	19-095	BC327
R16	13-283	1 KΩ "	Q4	19-093	BC238B
R17	13-283	1 KΩ "	Q5	19-095	BC327
R18	13-291	4,7 KΩ "	Q6	19-176	2N4918
R19	13-283	1 KΩ "	Q7	19-093	BC238B
R20	13-291	4,7 KΩ "	Q8	19-093	BC238B
R21	13-283	1 KΩ "			
R22	13-275	220 Ω "	S1	18-013	0,5 A MT
R23	13-270	82 Ω "	S2	18-014	10 A MT
R24	13-584	10 Ω 5W	S3		0,1 mm kobbertråd
C1	11-505	4,7 μF/25 V Tant			
C2	11-505	4,7 μF/25 V Tant			
C3	11-505	4,7 μF/25 V Tant			
C4	11-409	1 nF Ker			
C5	11-409	1 nF Ker			
C6	11-409	1 nF Ker			
C7	11-509	47 μF/6,3V Tant			
C9	11-505	4,7 μF 25 V Tant			
C10	11-406	330 pF Styr			
C11		500 μF 16 V Tant			
REL1	17-059	RS 6 < V			
Wirning for carrying bag no. 215-017. B 78 D 1 Tilhører tegn. nr.: 78121-2E2			Rettet:		Tegn.: Kontr.: Stykl. nr.: 78121-4S2

AP-RADIOTELEFON

Nr.	Kode	Data	Nr.	Kode	Data
R1	13-359	100 Ω 1/4W	REL2	17-041	MSK 12 PASI
R2	13-275	220 Ω 1/8W			
R3	13-287	2,2 KΩ "	D1	04-062	1N4148
R4	13-294	8,2 KΩ "	D2	04-062	1N4148
R5	13-283	1 KΩ "	D3	04-062	1N4148
R6	13-283	1 KΩ "	D4	04-062	1N4148
R7	13-272	120 KΩ "	D5	04-062	1N4148
R8	13-280	560 KΩ "	D6	04-045	BZX83-C4V3
R9	13-295	10 KΩ "	D7	04-060	1N4001
R10	13-295	10 KΩ "	D8	04-040	30S1
R11	13-295	10 KΩ "	D9	04-0628	1N4148
R12	13-295	10 KΩ "			
R13	13-283	1 KΩ "	Q1	19-093	BC238B
R14	13-295	10 KΩ "	Q2	19-093	BC238B
R15	13-295	10 KΩ "	Q3	19-095	BC327
R16	13-283	1 KΩ "	Q4	19-093	BC238B
R17	13-283	1 KΩ "	Q5	19-095	EC327
R18	13-291	4,7 KΩ "	Q6	19-176	2N4918
R19	13-283	1 KΩ "	Q7	19-093	BC238B
R20	13-291	4,7 KΩ "	Q8	19-093	BC238B
R21	13-283	1 KΩ "			
R22	13-275	220 Ω "	S1	18-013	0,5 A MT
R23	13-270	82 Ω "	S2	18-014	10 A MT
R24	13-584	10 Ω 5W	S3		0,1 mm kobbertråd
C1	11-505	4,7 μF/25 V Tant			
C2	11-505	4,7 μF/25 V Tant			
C3	11-505	4,7 μF/25 V Tant			
C4	11-409	1 nF Ker			
C5	11-409	1 nF Ker			
C6	11-409	1 nF Ker			
C7	11-509	47 μF/6,3V Tant			
C9	11-505	4,7 μF 25 V Tant			
C10	11-406	330 pF Styr			
C11		500 μF 16 V Tant			
REL1	17-059	RS 6 < V			
Wiring for carrying bag no. 215-016 B 78 D 1 Tilhører tegn. nr.: 79096-4E2			Rettet:		Tegn.: Kontr.: Stykl. nr. 79096-4E2